

# JVC

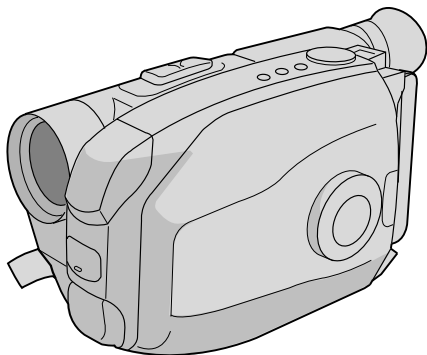

## COMPACT VHS CAMCORDER

# GR-AX930



*Compact VHS*



## INSTRUCTIONS

**For Customer Use:**

Enter below the Model No. and Serial No. which is located on the bottom of cabinet. Retain this information for future reference.

Model No. \_\_\_\_\_

Serial No. \_\_\_\_\_

**Dear Customer,**

Thank you for purchasing the JVC Compact VHS camcorder. Before use, please read the safety information and precautions contained in the following pages to ensure safe use of your new camcorder.

**Using This Instruction Manual**

- All major sections and subsections are listed in the Table Of Contents (☞ pg. 7).
- Notes appear after most subsections. Be sure to read these as well.
- Basic and advanced features/operation are separated for easier reference.

**It is recommended that you . . .**

- ..... refer to the Index (☞ pgs. 53 – 56) and familiarize yourself with button locations, etc. before use.
- ..... read thoroughly the Safety Precautions and Safety Instructions that follow. They contain extremely important information regarding the safe use of your new camcorder.

You are recommended to carefully read the cautions on pages 57 and 58 before use.

# SAFETY PRECAUTIONS



**CAUTION**

RISK OF ELECTRIC SHOCK  
DO NOT OPEN



CAUTION: TO REDUCE THE RISK OF ELECTRIC SHOCK,  
DO NOT REMOVE COVER (OR BACK).  
NO USER-SERVICEABLE PARTS INSIDE.  
REFER SERVICING TO QUALIFIED SERVICE PERSONNEL.



The lightning flash with arrowhead symbol, within an equilateral triangle, is intended to alert the user to the presence of uninsulated "dangerous voltage" within the product's enclosure that may be of sufficient magnitude to constitute a risk of electric shock to persons.



The exclamation point within an equilateral triangle is intended to alert the user to the presence of important operating and maintenance (servicing) instructions in the literature accompanying the appliance.

The AA-V15U AC Power Adapter/Charger should be used with:

AC 120 V~, 60 Hz in the USA and Canada,  
AC 110 – 240 V~, 50/60 Hz in other countries.

**CAUTION (applies to the AA-V15U)**

TO PREVENT ELECTRIC SHOCK MATCH WIDE BLADE OF PLUG TO WIDE SLOT, FULLY INSERT.

**ATTENTION (s'applique à l'AA-V15U)**

POUR ÉVITER LES CHOCS ÉLECTRIQUES, INTRODUIRE LA LÂME LA PLUS LARGE DE LA FICHE DANS LA BORNE CORRESPONDANTE DE LA PRISE ET POUSSER JUSQU'AU FOND.

**WARNING:**

**TO PREVENT FIRE OR SHOCK HAZARD, DO NOT EXPOSE THIS UNIT TO RAIN OR MOISTURE.**

**Warning on lithium battery**

The battery used in this device may present a fire or chemical burn hazard if mistreated. Do not recharge, disassemble, heat above 100°C (212°F) or incinerate.

Replace the battery with Maxell, Panasonic (Matsushita Electric), Sanyo or Sony CR2025; use of another battery may present a risk of fire or explosion.

- Dispose of used battery promptly.
- Keep away from children.
- Do not disassemble and do not dispose of in fire.

**NOTES:**

- The rating plate (serial number plate) and safety caution are on the bottom and/or the back of the main unit.
- The rating plate (serial number plate) of the AC Power Adapter/Charger is on its bottom.

This Class B digital apparatus meets all requirements of the Canadian Interference – Causing Equipment Regulations.

“Cet appareil numérique de la classe B respecte toutes les exigences du Règlement sur le matériel brouilleur du Canada.”

This camcorder is designed to be used with NTSC-type color television signals. It cannot be used for playback with a television of a different standard. However, live recording and viewfinder playback are possible anywhere. Use the BN-V12U/V18U/V22U/V25U battery packs and, to recharge them, the provided multi-voltage AC Power Adapter/Charger. (An appropriate conversion adapter may be necessary to accommodate different designs of AC outlets in different countries.)

**ATTENTION:**

The product that you have purchased is powered by a rechargeable battery. The battery is recyclable. At the end of its useful life, under various state and local laws, it may be illegal to dispose of this battery into the municipal waste stream. Check with your local solid waste officials for details in your area for recycling options or proper disposal.

# IMPORTANT PRODUCT SAFETY INSTRUCTIONS

Electrical energy can perform many useful functions. But improper use can result in potential electrical shock or fire hazards. This product has been engineered and manufactured to assure your personal safety. In order not to defeat the built-in safeguards, observe the following basic rules for its installation, use and servicing.

## ATTENTION:

Follow and obey all warnings and instructions marked on your product and its operating instructions. For your safety, please read all the safety and operating instructions before you operate this product and keep this manual for future reference.

## INSTALLATION

### 1. Grounding or Polarization

(A) Your product may be equipped with a polarized alternating-current line plug (a plug having one blade wider than the other). This plug will fit into the power outlet only one way. This is a safety feature.

If you are unable to insert the plug fully into the outlet, try reversing the plug. If the plug should still fail to fit, contact your electrician to replace your obsolete outlet. Do not defeat the safety purpose of the polarized plug.

(B) Your product may be equipped with a 3-wire grounding-type plug, a plug having a third (grounding) pin. This plug will only fit into a grounding-type power outlet. This is a safety feature.

If you are unable to insert the plug into the outlet, contact your electrician to replace your obsolete outlet. Do not defeat the safety purpose of the grounding-type plug.

### 2. Power Sources

Operate your product only from the type of power source indicated on the marking label. If you are not sure of the type of power supply to your home, consult your product dealer or local power company. If your product is intended to operate from battery power, or other sources, refer to the operating instructions.

### 3. Overloading

Do not overload wall outlets, extension cords, or integral convenience receptacles as this can result in a risk of fire or electric shock.

### 4. Power Cord Protection

Power supply cords should be routed so that they are not likely to be walked on or pinched by items placed upon or against them, paying particular attention to cords at plugs, convenience receptacles, and the point where they exit from the product.

### 5. Ventilation

Slots and openings in the cabinet are provided for ventilation. To ensure reliable operation of the product and to protect it from overheating, these openings must not be blocked or covered.

- Do not block the openings by placing the product on a bed, sofa, rug or other similar surface.
- Do not place the product in a built-in installation such as a bookcase or rack unless proper ventilation is provided or the manufacturer's instructions have been adhered to.

### 6. Wall or Ceiling Mounting

The product should be mounted to a wall or ceiling only as recommended by the manufacturer.

## ANTENNA INSTALLATION INSTRUCTIONS

### 1. Outdoor Antenna Grounding

If an outside antenna or cable system is connected to the product, be sure the antenna or cable system is grounded so as to provide some protection against voltage surges and built-up static charges. Article 810 of the National Electrical Code, ANSI/NFPA 70, provides information with regard to proper grounding of the mast and supporting structure, grounding of the lead-in wire to an antenna discharge unit, size of grounding conductors, location of antenna discharge unit, connection to grounding electrodes, and requirements for the grounding electrode.

### 2. Lightning

For added protection for this product during a lightning storm, or when it is left unattended and unused for long periods of time, unplug it from the wall outlet and disconnect the antenna or cable system. This will prevent damage to the product due to lightning and power-line surges.

### 3. Power Lines

An outside antenna system should not be located in the vicinity of overhead power lines or other electric light or power circuits, or where it can fall into such power lines or circuits. When installing an outside antenna system, extreme care should be taken to keep from touching such power lines or circuits as contact with them might be fatal.

#### EXAMPLE OF ANTENNA GROUNDING AS PER NATIONAL ELECTRICAL CODE, ANSI/NFPA 70

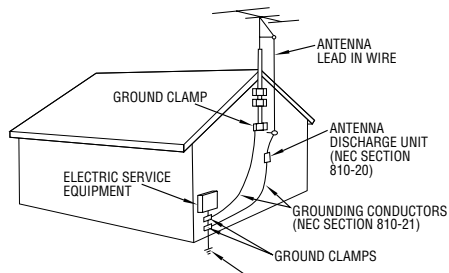

POWER SERVICE GROUNDING ELECTRODE SYSTEM  
(NEC ART 250. PART H)

NEC - NATIONAL ELECTRICAL CODE

## USE

### 1. Accessories

#### To avoid personal injury:

- Do not place this product on an unstable cart, stand, tripod, bracket or table. It may fall, causing serious injury to a child or adult, and serious damage to the product.
- Use only with a cart, stand, tripod, bracket, or table recommended by the manufacturer or sold with the product.
- Use a mounting accessory recommended by the manufacturer and follow the manufacturer's instructions for any mounting of the product.
- Do not try to roll a cart with small casters across thresholds or deep-pile carpets.

### 2. Product and Cart Combination

A product and cart combination should be moved with care. Quick stops, excessive force, and uneven surfaces may cause the product and cart combination to overturn.

### 3. Water and Moisture

Do not use this product near water—for example, near a bath tub, wash bowl, kitchen sink or laundry tub, in a wet basement, or near a swimming pool and the like.

PORTABLE CART WARNING  
(Symbol provided by RETAC)



### 4. Object and Liquid Entry

Never push objects of any kind into this product through openings as they may touch dangerous voltage points or short-out parts that could result in a fire or electric shock. Never spill liquid of any kind on the product.

### 5. Attachments

Do not use attachments not recommended by the manufacturer of this product as they may cause hazards.

### 6. Cleaning

Unplug this product from the wall outlet before cleaning. Do not use liquid cleaners or aerosol cleaners. Use a damp cloth for cleaning.

### 7. Heat

The product should be situated away from heat sources such as radiators, heat registers, stoves, or other products (including amplifiers) that produce heat.

## SERVICING

### 1. Servicing

If your product is not operating correctly or exhibits a marked change in performance and you are unable to restore normal operation by following the detailed procedure in its operating instructions, do not attempt to service it yourself as opening or removing covers may expose you to dangerous voltage or other hazards. Refer all servicing to qualified service personnel.

### 2. Damage Requiring Service

Unplug this product from the wall outlet and refer servicing to qualified service personnel under the following conditions:

- When the power supply cord or plug is damaged.
- If liquid has been spilled, or objects have fallen into the product.
- If the product has been exposed to rain or water.
- If the product does not operate normally by following the operating instructions. Adjust only those controls that are covered by the operating instructions as an improper adjustment of other controls may result in damage and will often require extensive work by a qualified technician to restore the product to its normal operation.
- If the product has been dropped or damaged in any way.
- When the product exhibits a distinct change in performance—this indicates a need for service.

### 3. Replacement Parts

When replacement parts are required, be sure the service technician has used replacement parts specified by the manufacturer or have the same characteristics as the original part. Unauthorized substitutions may result in fire, electric shock or other hazards.

### 4. Safety Check

Upon completion of any service or repairs to this product, ask the service technician to perform safety checks to determine that the product is in safe operating condition.

## SUPPLY POWER

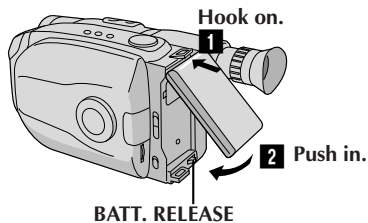

### Using the battery pack

- 1 Hook-on the battery pack's top end to the camcorder. (Charging procedure, ☞ pg. 8)
- 2 Push in the battery pack until it locks into place.

### To remove the battery pack

Slide **BATT. RELEASE** and pull out the battery pack.

## INSERTING A VIDEO CASSETTE

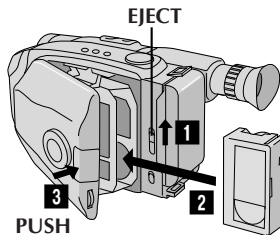

- 1 Slide **EJECT** to open the cassette holder.
- 2 Insert a video cassette.
- 3 Press **PUSH** to close the cassette holder. (For more details, ☞ pg. 13)

## PLAYBACK

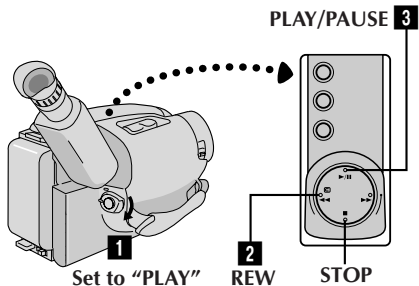

- 1 Set the Power Switch to "PLAY".
- 2 Press **REW**.  
— The tape will automatically stop at the beginning of the tape.
- 3 Press **PLAY/PAUSE**.  
— Playback starts and the playback picture appears.

• To stop playback, press **STOP**.  
(For more details, ☞ pg. 38.)

**Or simply play back the tape on a VHS VCR using the Cassette Adapter (VHS Playpak).** ☞ pg. 36

## SHOOTING

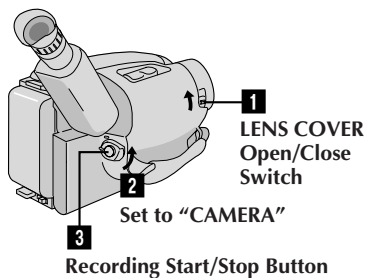

- 1 Slide the **LENS COVER** Open/Close Switch to open the lens cover.
  - 2 Set the Power Switch to "CAMERA".  
— The power indicator will light and an image will appear.
  - 3 Press the Recording Start/Stop Button.  
— Recording starts.
- To stop recording temporarily, momentarily press the Recording Start/Stop Button once again.  
(For more details, ☞ pgs. 16, 17)

## REMEMBER

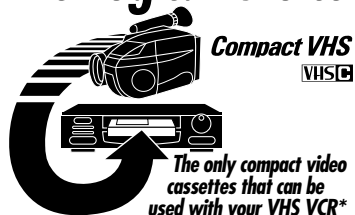
**The Logical Choice**

The only compact video cassettes that can be used with your VHS VCR\*

\*with VHS Playpak

**Program AE with Special Effects (pg. 22)**

- Auto Mode Lock
- Auto Mode Release
- Electronic Fog Filter
- ND Effect
- Sepia
- Twilight
- Sports
- Nega/Posi
- 1/2000 sec. High Speed Shutter

**Program Manager II (pg. 22 - 35)**

Program AE with Special Effects, Fade/Wipe, Wide, Super LoLux, Instant Title, Menu Adjustment (Focus, Exposure Control and so on.)

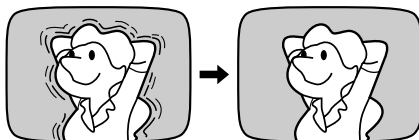
**Integrated Auto Light (pg. 21)****Picture Stabilizer (pg. 19)****Digital Hyper Zoom (pg. 18)**

Zoom-in

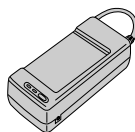

Zoom-out

**PROVIDED ACCESSORIES**

- AC Power Adapter/Charger AA-V15U

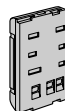

- Battery Pack BN-V18U

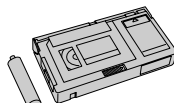

- Cassette Adapter (VHS Playpak) C-P7U

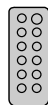

- Remote Control Unit RM-V705U



- Lithium Battery CR2025 x 2 (for clock operation and remote control unit)

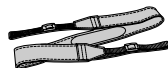

- Shoulder Strap



- DC Cord

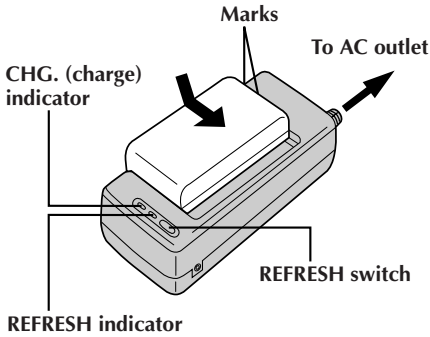

<b>GETTING STARTED</b>	<b>8</b>
Power .....	8
Clock (Lithium) Battery Insertion/Removal .....	10
Date/Time Setting .....	11
Recording Mode Setting .....	12
Tape Length Setting .....	12
Loading/Unloading A Cassette .....	13
Grip Adjustment .....	14
Viewfinder Adjustment .....	14
Shoulder Strap Attachment .....	15
Tripod Mounting .....	15
<b>RECORDING</b>	<b>16</b>
Basic Recording .....	16
Basic Features .....	18
Advanced Features .....	22
<b>PLAYBACK</b>	<b>36</b>
Using The Cassette Adapter .....	36
Basic Connections .....	37
Basic Playback .....	38
Features .....	39
<b>TAPE DUBBING</b>	<b>41</b>
<b>USING REMOTE CONTROL UNIT</b>	<b>42</b>
Random Assemble Editing .....	44
Insert Editing .....	48
Audio Dubbing .....	49
<b>USER MAINTENANCE</b>	<b>50</b>
<b>TROUBLESHOOTING</b>	<b>51</b>
<b>INDEX</b>	<b>53</b>
Viewfinder Indications .....	53
Controls .....	54
Connectors .....	54
Indicators .....	54
Other Parts .....	54
Terms .....	56
<b>CAUTIONS</b>	<b>57</b>
<b>SPECIFICATIONS</b>	<b>59</b>
<b>OPTIONAL ACCESSORIES</b>	<b>59</b>
<b>ESPAÑOL</b>	<b>60</b>
<b>FOR SERVICING (Only in U.S.A.)</b>	<b>62</b>
<b>WARRANTY (Only in U.S.A.)</b>	<b>63</b>

**REFRESH**

The AC power adapter features a REFRESH function that allows you to fully discharge the battery pack before recharging. Perform the REFRESH function after no less than 5 chargings.

**To discharge the battery . . .**

..... attach the battery pack to the adapter as shown in the above illustration. Then push REFRESH. The REFRESH indicator lights when discharging starts, and goes out when discharging is complete.

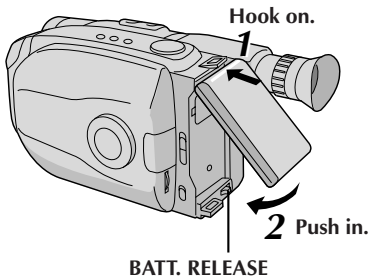
**ATTENTION:**

Before detaching the power source, make sure that the camcorder's power is turned off. Failure to do so can result in a camcorder malfunction.

**Power**

This camcorder's 3-way power supply system lets you choose the most appropriate source of power.

**NOTES:**

- No function is available without power supply.
- Use only specified power supply.
- Do not use provided power supply units with other equipment.

**CHARGING THE BATTERY PACK****SUPPLY POWER**

- 1 Connect the charger's AC power cord to a wall outlet.

**ATTACH BATTERY PACK**

- 2 Align the marks and slide the battery pack in the direction of the arrow until it locks in place.

- The CHG. indicator begins blinking to indicate charging has started.

**DETACH BATTERY PACK**

- 3 When the CHG. indicator stops blinking but stays lit, charging is finished. Slide the battery pack opposite the direction of the arrow.

BATT. PACK	CHARGE	DISCHARGE
BN-V12U	approx. 1 hr. 10 min.	approx. 3 hrs. 30 min.
BN-V18U	approx. 1 hr. 40 min.	approx. 5 hrs. 30 min.
BN-V22U	approx. 2 hrs. 10 min.	approx. 7 hrs.
BN-V25U	approx. 2 hrs. 40 min.	approx. 10 hrs.

**USING THE BATTERY PACK****ATTACH BATTERY PACK**

- 1 Hook its top end to the camcorder and push the battery pack in until it locks in place.

**DETACH BATTERY PACK**

- 2 Slide **BATT. RELEASE** and pull out the battery pack.

BATT. PACK	Approximate recording time (unit: min.)	
BN-V12U	75	( 40 )
BN-V18U	110	( 65 )
BN-V22U	150	( 90 )
BN-V25U	200	( 120 )

( ): when the video light is on.



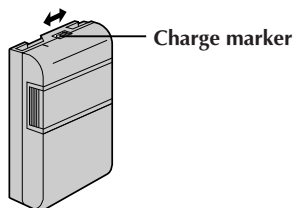

## CHARGE MARKER

A charge marker is provided on the battery pack to help you remember whether it has been charged or not. Two colors are provided (red and black)—you choose which one means charged and which means discharged.

- The battery pack BN-V18U does not have a charge marker.

## NOTES:

- The recording time per charge is affected by such factors as the time spent in Record-Standby mode and the frequency of zooming. It is safer to have spare battery packs.
- Charging times noted on page 8 are for fully discharged battery pack, and discharging times are for fully charged battery pack.
- Charging and discharging times vary according to the ambient temperature and the status of the battery pack.
- Remember to set the charge marker after charging a battery pack or after detaching a discharged one from your camcorder.
- Perform the REFRESH function after no less than 5 chargings.
- While the AC Power Adapter/Charger's power cord is disconnected from the AC outlet, it is possible to discharge the battery by pressing the REFRESH switch. During that time, the AC Power Adapter/Charger does not charge the battery. When discharging is complete, detach the battery from the AC Power Adapter/Charger to store it.
- High temperatures can damage the battery pack, so use only where good ventilation is available. Don't allow it to discharge in container, such as a bag.
- If you stop recharging or discharging part way through, make sure to remove the battery pack before unplugging the adapter's AC cord.
- Remove the battery pack from the adapter immediately after discharging.
- To avoid interference with reception, do not use the AC Power Adapter/Charger near a radio.
- Make sure you unplug the DC cord before charging or discharging the battery pack.
- The CHG. indicator may not light properly with a brand new battery pack, or with one that's been stored for an extended period. In this case, remove and reattach the battery pack and recharge it. The CHG. indicator should blink during recharging. If not, contact your nearest JVC dealer.

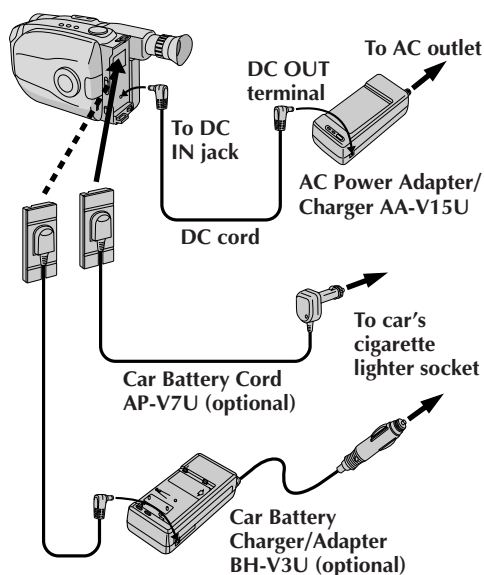

## USING A CAR BATTERY

Use the optional Car Battery Cord or Car Battery Charger/Adapter (connect as shown in the illustration to the left).

## NOTES:

- When using the car battery, leave the engine idling.
- The optional Car Battery Charger (BH-V3U) can also be used to charge the battery pack.
- When using the optional Car Battery Charger or Car Battery Cord (AP-V7U), refer to the respective instruction booklet.

## USING AC POWER

Use the AC Power Adapter (connect as shown in the illustration to the left).

## NOTE:

The supplied AC Power Adapter/Charger features automatic voltage selection in the AC range from 110 V to 240 V.

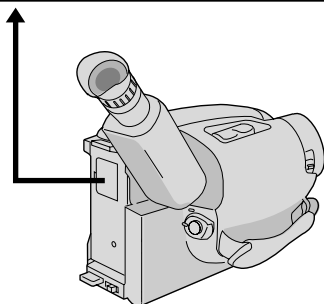
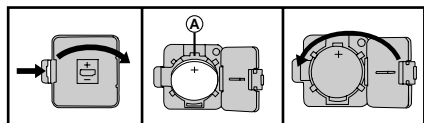

## Clock (Lithium) Battery Insertion/Removal

This battery is necessary for clock operation and to perform date/time settings.

### SWITCH OFF POWER

- 1 Switch off the unit's power and remove the power supply unit.

### OPEN COVER

- 2 Open the clock battery compartment cover while pressing the release tab.

### REMOVE BATTERY (when replacing)

- 3 Insert a pointed, non-metallic object between the battery and the compartment (A) and pull the battery out.

### INSERT BATTERY

- 4 Ensure that the plus (+) side is up and insert a CR2025 lithium battery and push it in.

### CLOSE COVER

- 5 Close the compartment cover until it clicks in place.

### NOTE:

See "SAFETY PRECAUTIONS" (pg. 2) for information on safe handling of lithium batteries.

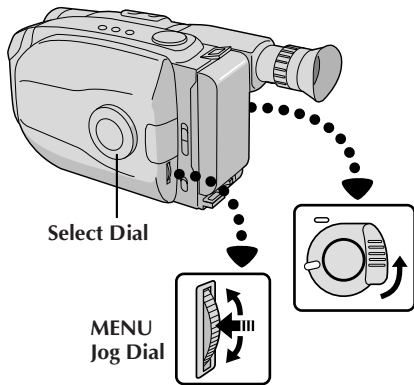

## Viewfinder

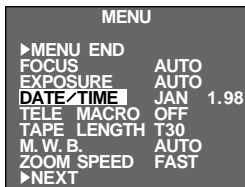

## Menu Screen



## DATE/TIME Setting Menu

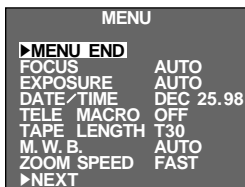

## Date/Time Setting

## ACCESS MENU SCREEN

- 1 First set the Power Switch to "CAMERA". Turn the Select Dial to any position except AUTO LOCK, then press the MENU Jog Dial.

## SELECT FUNCTION

- 2 Rotate the MENU Jog Dial to move the highlight bar to "DATE/TIME", then press it. The DATE/TIME Setting Menu appears.

- If you decide you want to return the date and time to the previous settings, rotate the MENU Jog Dial to move highlight bar to "EXIT" and press it, then go to step 6.
- If you want to set only the time without changing the date, go to step 4.

## SET DATE

- 3 Rotate the MENU Jog Dial to move the highlight bar to the item you want to set and then press it. When the setting begins blinking, rotate the MENU Jog Dial until the correct setting appears and then press it. The setting stops blinking.

- Repeat this procedure until you're satisfied with the Date settings ("YEAR", "MONTH" and "DAY").

## SET TIME

- 4 Rotate the MENU Jog Dial to move the highlight bar to "TIME" and then press it. When the hour setting begins blinking, rotate the MENU Jog Dial until the correct setting appears and then press it. When the hour setting stops blinking and the minute setting begins blinking, rotate the MENU Jog Dial until the correct setting appears and then press it. The minute setting stops blinking.

## START CLOCK OPERATION

- 5 When none of these settings (YEAR, MONTH, DAY, TIME) blinks, rotate the MENU Jog Dial to move the highlight bar to "EXIT", and press it. The Menu Screen appears and "MENU END" is highlighted.

## CLOSE MENU

- 6 Press the MENU Jog Dial.

## NOTE:

To display the date and time in the viewfinder and on a connected TV, see "Date/Time Insert" (pg. 20).

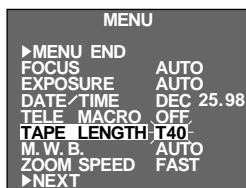
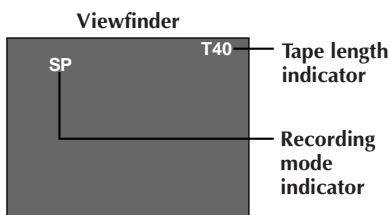
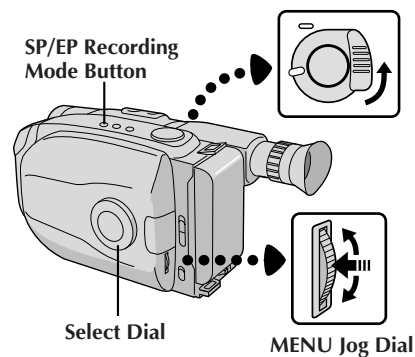

Menu Screen

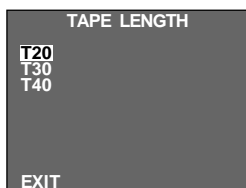

TAPE LENGTH Setting Menu

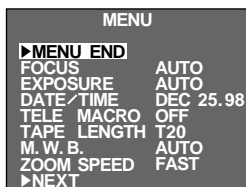

## Recording Mode Setting

Set depending on your preference.

### 1 SET RECORDING MODE

First set the Power Switch to "CAMERA". Press **SP/EP** Button for more than 1 second. "SP" (Standard Play) provides higher picture and sound quality and is better for dubbing, while "EP" (Extended Play) is more economical, providing three times as the recording time.

#### NOTE:

*If the recording mode is switched during recording, the playback picture will be blurred at the switching point.*

## Tape Length Setting

Set the tape length according to the length of the tape used.

### 1 ACCESS MENU SCREEN

First set the Power Switch to "CAMERA". Turn the Select Dial to any position except AUTO LOCK, then press the MENU Jog Dial.

### 2 SELECT FUNCTION

Rotate the MENU Jog Dial to move the highlight bar to "TAPE LENGTH", then press it. The TAPE LENGTH Setting Menu appears.

### 3 SET TAPE LENGTH

Rotate the MENU Jog Dial to move the highlight bar to the correct setting. T20=20 minutes of recording time, T30=30 minutes, and T40=40 minutes (in SP).

- If you decide you want to return the tape length to the previous setting, rotate the MENU Jog Dial to move the highlight bar to "EXIT".

### 4 CLOSE MENU

Press the MENU Jog Dial. The Menu Screen reappears and the highlight bar is on "MENU END". Then press the MENU Jog Dial again to close the Menu Screen.

#### NOTES:

- The displayed tape remaining time (⌚ pg. 17) is correct only if the correct tape length has been selected.
- Once you have set the tape length, it remains unchanged even if the Select Dial is returned to AUTO LOCK.

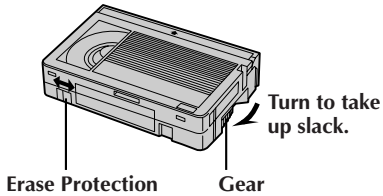
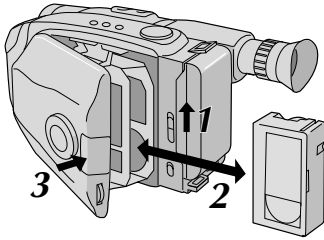

## Loading/Unloading A Cassette

- 1** **OPEN CASSETTE HOLDER**  
Slide **EJECT** until the holder opens. Do not use force to open.
- 2** **INSERT/REMOVE CASSETTE**  
Make sure the label is facing outward.
- 3** **CLOSE CASSETTE HOLDER**  
Press **PUSH** and make sure the holder is closed and locked.

### NOTES:

- A cassette holder can't be opened unless a power supply is attached.
- Make sure that the tape is not slack when loading the cassette. If there is any slack, turn the gear on the cassette in the direction of the arrow to take up the slack.
- Make sure the Erase Protection tab is in the position that allows recording. If not, slide the tab. Some cassettes have removable tabs. If the tab has been removed, cover the hole with adhesive tape.
- The cassette holder can't be opened while the camcorder is in the record mode.

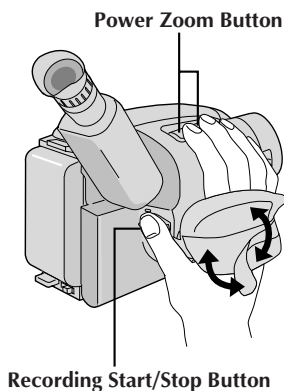

## Grip Adjustment

### EXPAND LOOP

- 1 Separate the Velcro strip.

### INSERT HAND

- 2 Pass your right hand through the loop and grasp the grip.

### ADJUST STRAP LENGTH

- 3 Adjust so your thumb and fingers can easily operate the Recording Start/Stop Button and Power Zoom Button. Refasten the Velcro strip.

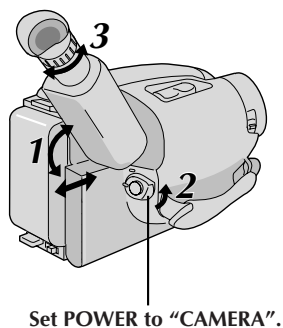

## Viewfinder Adjustment

### POSITION VIEWFINDER

- 1 Adjust the viewfinder manually for best viewability (see illustration at left).

### SELECT MODE

- 2 Set the Power Switch to CAMERA.

### ADJUST DIOPTR

- 3 Turn the Diopter Adjustment Control until the indications in the viewfinder are clearly focused.

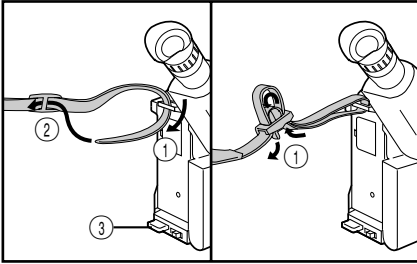

## Shoulder Strap Attachment

### ATTACH STRAP

- 1 Following the illustration at left, thread the strap through the top of the eyelet ①, then fold it back and thread it through the buckle ②. Repeat the procedure to attach the other end of the strap to the other eyelet ③, making sure the strap isn't twisted.

### ADJUST LENGTH

- 2 Adjust as shown in the illustration at left ①.

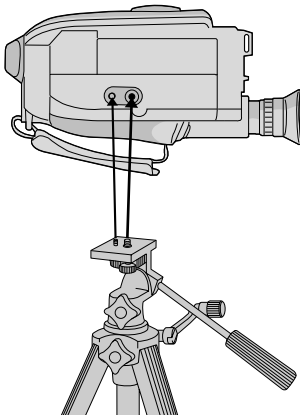

## Tripod Mounting

### ALIGN AND TIGHTEN

- 1 Align the screw and camera direction stud on the tripod with the camera's mounting socket and stud hole. Then tighten the screw.

### CAUTION:

When using a tripod, be sure to open and extend its legs fully to stabilize the camcorder. To prevent damage to the unit caused by falling over, do not use a small-sized tripod.

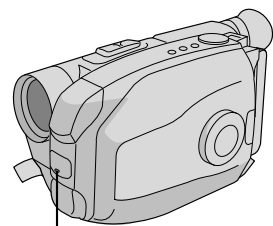
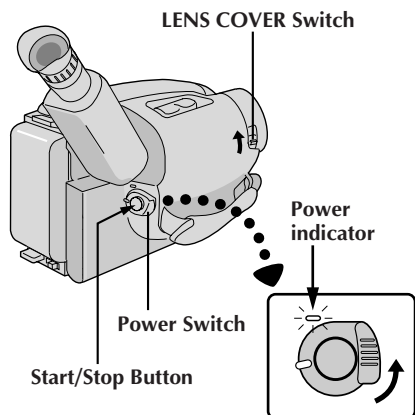

Tally lamp  
(lights while recording  
is in progress)

## NOTE:

You should already have performed the procedures listed below. If not, do so before continuing.

- Power (☞ pg. 8)
- Recording Mode/Tape Length Setting (☞ pg. 12)
- Grip Adjustment (☞ pg. 14)

## LOAD A CASSETTE

- 1 Slide **EJECT** to open the cassette holder, then insert the cassette with the label facing out. Press **PUSH** to ensure the holder is closed and locked.

## ENTER RECORD-STANDBY MODE

- 2 Slide the **LENS COVER** Open/Close Switch to open the lens cover, then set the Power Switch to **CAMERA**.

- The power indicator lights and the camcorder enters the Record-Standby mode.
- The scene you're aimed at appears on the viewfinder screen, with the word "PAUSE" superimposed upon it.

## START SHOOTING

- 3 Press the Recording Start/Stop Button.

- "REC" appears in the viewfinder while recording is in progress.



## Tape remaining time indicator

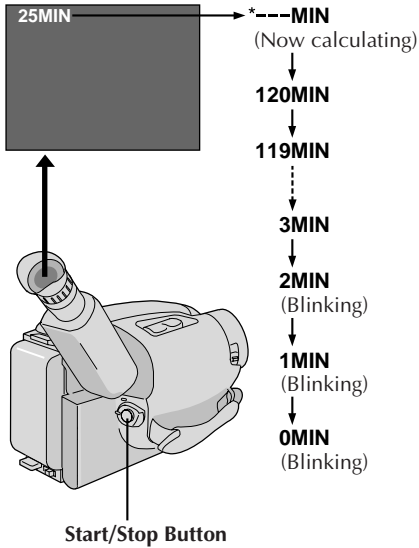

## STOP RECORDING

**4** Press the Recording Start/Stop Button again to stop recording.

- The camcorder re-enters the Record-Standby mode.

## NOTES:

- A cassette holder can't be opened unless a power supply is attached.
- There may be a delay after you slide EJECT until the holder opens. Do not use force.
- The displayed remaining time is approximate.
- The time required to calculate the remaining tape length, and the accuracy of the calculation, may vary according to the type of tape used.
- The tape remaining time indicator is correct only if the correct tape length has been selected (☞ pg. 12).
- "TAPE END" appears when the tape reaches its end, and the power goes off automatically if left in this condition for 5 minutes. "TAPE END" also appears when a cassette whose tape is already at its end is loaded.
- If the Record-Standby mode continues for 5 minutes without performing Zoom or any other operations, the camcorder's power shuts off automatically. Set the Power Switch to "POWER OFF", and then back to "CAMERA" to turn the camcorder on again.
- If the Recording Start/Stop Button is pressed after the Record-Standby mode has continued for over 5 minutes, recording may not start immediately.
- If you're recording on a cassette from the middle (such as when a tape is removed and re-inserted during recording), use the Retake function (☞ pg. 19) to find the end of the last recording so you don't erase any of it.
- The LENS COVER warning blinks for about 5 seconds when the camcorder is turned on when the cover is closed.

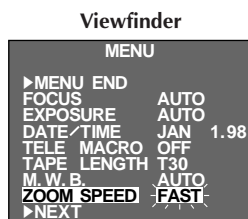
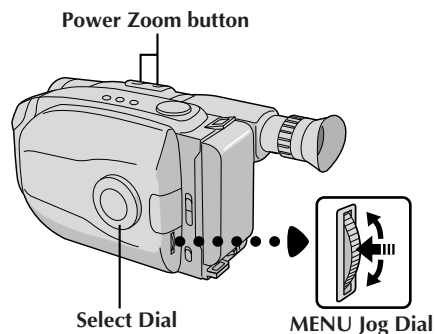
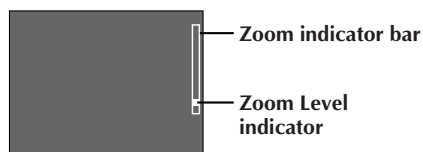
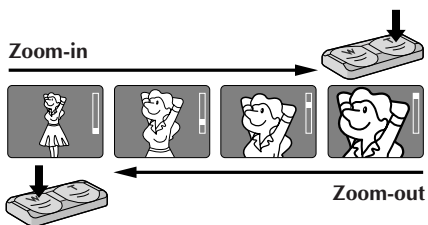

Menu Screen

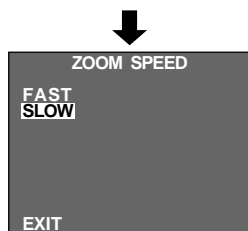

ZOOM SPEED Setting Menu

**FEATURE:**  
**PURPOSE:**

**OPERATION:**

### Zooming

To produce the zoom in/out effect, or an instantaneous change in image magnification.

Digital circuitry doubles the maximum 22x magnification offered by optical zoom. This system is called Digital Zoom.

#### Zoom In

Press the "T" of the Power Zoom Button.

#### Zoom Out

Press "W" of the Power Zoom Button.

■ Zooming speed is available. A total of 4 zoom speeds are available. 2 speeds can be selected depending on how hard the Power Zoom Button is pressed (press the button fully for regular-speed, press it lightly for slow-speed), while 2 speed levels (FAST/SLOW) can be selected in the ZOOM SPEED Menu depending on the overall speed you prefer.

The combinations of zoom speeds are shown in the chart below.

#### Changing the ZOOM SPEED in the Menu

- 1) Set the Select Dial to any position except AUTO LOCK and press the MENU Jog Dial. The Menu Screen appears.
- 2) Rotate the MENU Jog Dial to move the highlight bar to "ZOOM SPEED", then press it. The ZOOM SPEED Setting Menu appears.
- 3) Rotate the MENU Jog Dial to move the highlight bar to the desired speed and press it twice. The Menu Screen disappears and setting is completed.

**NOTES:**

- Focusing may become unstable during Zooming. In this case, set the zoom while in Record-Standby, lock the focus by using the manual focus (☞ pg. 31), then zoom in or out in Record mode.
- The zoom level indicator (■) moves during zoom. Once the zoom level indicator reaches the top of the zoom indicator bar, all magnification from that point is through digital processing.
- During Digital Zoom, the quality of image may suffer. To deactivate Digital Zoom, set "D.ZOOM" to "OFF" in the Menu Screen (☞ pg. 29).

### Zooming Speed ( 1 – 4 in order of speed)

"ZOOM SPEED" in the Menu Screen	Pressing the Power Zoom Button	
	fully	lightly
FAST	1 (fastest)	3
SLOW	2	4 (slowest)

■ : when the Select Dial is set to AUTO LOCK.

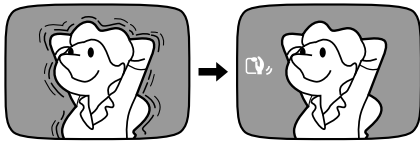
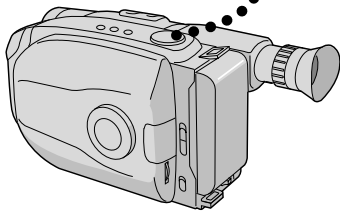
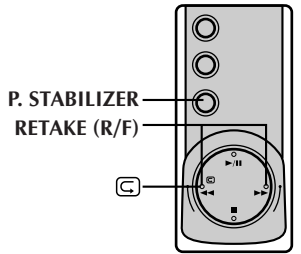

<p><b>FEATURE:</b> <b>PURPOSE:</b></p> <p><b>OPERATION:</b></p> <p><b>NOTE:</b></p>	<p><b>Quick Review</b> To check the end of the last recording.</p> <p>1) Press "Q" and release quickly during the Record-Standby mode.        ■ Tape is rewound for about 2 seconds and played back automatically, then pauses in Record-Standby mode for the next shot.</p> <p><i>Distortion may occur at start of playback. This is normal.</i></p>
<p><b>FEATURE:</b> <b>PURPOSE:</b> <b>OPERATION:</b></p> <p><b>NOTE:</b></p>	<p><b>Retake</b> To re-record certain segments.</p> <p>1) Make sure the camcorder is in the Record-Standby mode.        2) Press either <b>RETAKE</b> button to reach the start point for new recording. Pressing "F" forwards the tape and pressing "R" reverses it.        3) Press Recording Start/Stop Button to start recording.</p> <p><i>Noise may appear during Retake. This is normal.</i></p>
<p><b>FEATURE:</b> <b>PURPOSE:</b></p> <p><b>OPERATION:</b></p> <p><b>NOTES:</b></p>	<p><b>Picture Stabilizer</b> To compensate for unstable images caused by camera-shake, particularly at high magnification.</p> <p>1) Press <b>P. STABILIZER</b>. "Q" appears.        ■ To switch off the Picture Stabilizer, press <b>P. STABILIZER</b>. The indicator disappears.</p> <ul style="list-style-type: none"> <li>● <i>Accurate stabilization may not be possible if hand shake is excessive, or under the following conditions:</i> <ul style="list-style-type: none"> <li>• When shooting subjects with vertical or horizontal stripes.</li> <li>• When shooting dark or dim subjects.</li> <li>• When shooting subjects with excessive backlighting.</li> <li>• When shooting scenes with movement in various directions.</li> <li>• When shooting scenes with low-contrast backgrounds.</li> </ul> </li> <li>● <i>Switch off the Picture Stabilizer when recording with the camcorder on a tripod.</i></li> </ul>

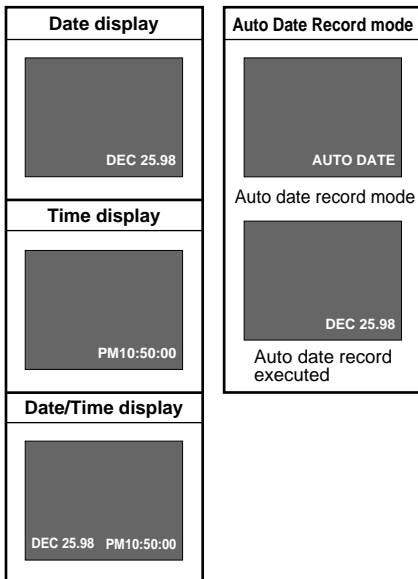
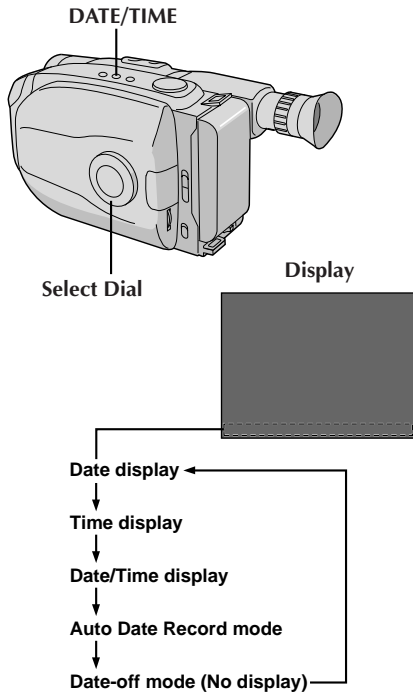
**FEATURE:**  
**PURPOSE:****OPERATION:****NOTES:****Date/Time Insert**

To display the date and time in the viewfinder or on a connected color monitor, as well as to record them manually or automatically.

- 1)** Turn the Select Dial to any position except AUTO LOCK.  
**2)** Choose a display mode by pressing **DATE/TIME** repeatedly while in Record-Standby to cycle through the modes as shown in the illustration at left.

- You should have already performed the Date/Time Setting procedure (pg. 11). If you haven't, do so first.

**DISPLAY**

- The selected display can be recorded.
- If you don't want to record the display, select the Date-off mode before shooting.
- If you want to delete the display during shooting, press **DATE/TIME**.
- To recall the display, engage the Record-Standby mode and press **DATE/TIME** repeatedly until the desired display appears.

**AUTO DATE RECORD**

- Your camcorder automatically records the date for about 5 seconds after recording is initiated in the following situations:
  - After changing the date.
  - After loading a cassette.
  - After Auto Date Record mode is selected by pressing **DATE/TIME**.
 In this mode, the date is replaced after 5 seconds with "AUTO DATE" but this is not recorded.
- Setting the Select Dial to AUTO LOCK always engages the Auto Date Record mode, and disables all other modes.

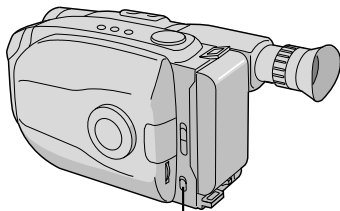

LIGHT OFF/AUTO/ON

### DANGER

- The video light can become extremely hot. Do not touch it either while in operation or soon after turning it off, otherwise serious injury may result.
- Do not place the camcorder into the carrying case immediately after using the video light, since it remains extremely hot for some time.
- When operating, keep a distance of about 30 cm. (1 ft.) between the video light and people or objects.
- Do not use near flammable or explosive materials.
- It is recommended that you consult your nearest JVC dealer for replacing the video light.

#### FEATURE:

#### PURPOSE:

#### OPERATION:

#### NOTES:

#### Video Light

To brighten the scene when natural lighting is too dim.

#### 1) Set the LIGHT OFF/AUTO/ON

Switch as required:

**ON** : Always keeps the light on as long as the camcorder is turned on.

**AUTO** : Automatically turns on the light when the camcorder senses insufficient lighting on the subject.

**OFF** : Turns off the light.

- The video light can only be used with the camcorder's power on.
- It is recommended to set the white balance (☞ pg. 33) to HALOGEN mode (☛) when you use the video light.
- When not using the video light, turn it off to save battery power.
- *Even if the battery indicator (☐) does not blink if the battery pack's charge is low, the camcorder may turn off automatically when you turn on the video light, or when you start recording with the video light turned on.*
- *When the LIGHT OFF/AUTO/ON Switch is set to "AUTO":*
  - *Depending on the lighting conditions, the video light may keep turning on and off. In this case, manually switch the light on or off using the LIGHT OFF/AUTO/ON switch.*
  - *While the Sports or High-Speed Shutter mode (☞ pg. 23) is engaged, the light is likely to stay on.*
  - *While the Twilight mode (☞ pg. 23) is engaged, the light will not activate.*

1 second later, the mode is activated.

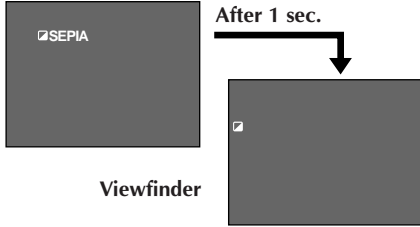

Viewfinder

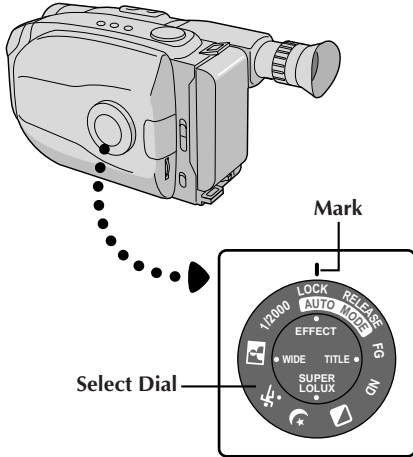

Select Dial

## Program AE With Special Effects

All you have to do to access any of the variety of shooting effects is to turn the Select Dial.

### SELECT MODE

**1** Turn the Select Dial until the symbol of the function you want is aligned with the mark.

- The selected mode's name and its indication are displayed for approx. 1 second. Then the name disappears, and only the indication remains. The mode is activated.
- When Auto Mode Lock or Auto Mode Release mode is selected, only the mode's name is displayed. Then the name disappears and the mode is activated.

### NOTES:

- Only one effect can be engaged at a time.
- The screen becomes slightly reddish when the Fade/Wipe (pg. 24) is used in the Sepia mode.
- The screen becomes slightly dark in the High Speed Shutter mode. Use in well-lit situations.
- In the High Speed Shutter or Sports modes, picture color may be adversely affected if subject is lit by fluorescent or mercury-vapor lights.

Dial symbol	Viewfinder indication	Mode
LOCK	AUTO LOCK	Auto Mode Lock

### Auto Mode Lock

Locks the camcorder in Full Auto mode, preventing incorrect operation due to accidental button pressing during shooting.

- In this mode the following controls are disabled; DATE/TIME display select, and the Menu Jog Dial.

RELEASE	AUTO RELEASE	Auto Mode Release
---------	--------------	-------------------

### Auto Mode Release

Re-enables the controls that were disabled by Auto Mode Lock.

FG	FG : FOG	Electronic Fog Filter
----	----------	-----------------------

### Electronic Fog Filter

Makes the picture look misty white, as when an external fog filter is attached to the lens. Softens the image and gives it a “fantasy” look.

ND	ND:ND EFFECT	ND Effect
----	--------------	-----------

### ND Effect

A black mist darkens the picture, as when an ND filter is used. Helps to counter the effects of glare on the subject.

	SEPIA	Sepia
---	-------	-------

### Sepia

The scene being shot is recorded in sepia-tinted (reddish-brown) monochrome, giving the effect of an older movie. Use together with Wide (pg. 25) for the authentic look of a classic Hollywood movie.

Dial symbol	Viewfinder indication	Mode
	TWILIGHT	Twilight

### Twilight

Dusk, twilight scenery, fireworks, etc., look more natural and dramatic. The following happens when Twilight mode is selected:

- Auto gain control is turned off.
- White Balance is set to “☀️” (FINE day mode), but can also be manually changed to another mode (pg. 33).
- Auto Focus becomes available only in the range of 10 m (33 ft.) to infinity. To focus when the subject-to-camera distance is less than 10 m (33 ft.), use manual focusing (pg. 31).

	SPORTS	Sports
---	--------	--------

### Sports

High shutter speed clearly captures fast-moving action.

	NEGA POSI	Nega/Posi
---	-----------	-----------

### Nega/Posi (Negative/Positive)

The colors of a picture are reversed.

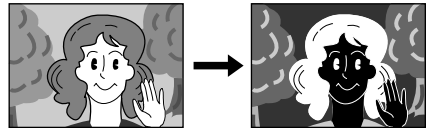

NEGA POSI mode

1/2000	 2 S 1/2000	1/2000 sec. High Speed Shutter
--------	--	-----------------------------------

### High-Speed Shutter (1/2000s.)

Captures faster action than Sports mode.

[Ex. : Fader]

Fade-in

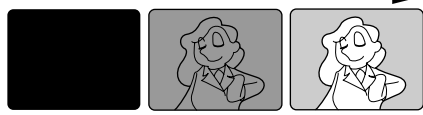

Fade-out

Function indication

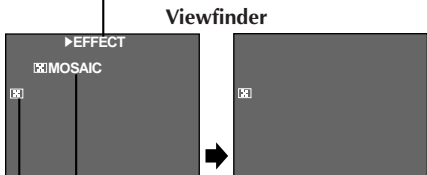

After 2 sec.

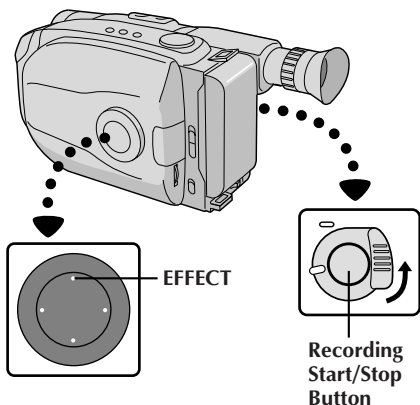
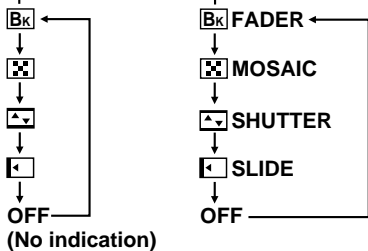

## Fade/Wipe

These effects let you make pro-style scene transitions. Fade- or wipe-in works at recording start, and fade- or wipe-out works at recording end or when you enter Record-Standby mode.

### ENGAGE FADE- OR WIPE-STANDBY MODE

**1** Press **EFFECT** to cycle through the modes as shown at left. Once the desired mode appears, it is selected and reserved.

- The selected mode's name and its indication are displayed for approx. 2 seconds. Then the name disappears, and only the indication remains.

### START OR END RECORDING

**2** Press Recording Start/Stop Button to activate fade-in/out or wipe-in/out.

### TO CANCEL FADE- OR WIPE-STANDBY MODE

**3** Press **EFFECT** repeatedly until "OFF" appears.

- "OFF" is displayed for approx. 2 seconds and the fade/wipe standby mode is canceled.

#### **Bk** Fader

Fades in/out to a black screen.

#### **MOSAIC** Mosaic (Fader)

Gradually turns/returns the picture into/from a mosaic pattern.

#### **SHUTTER** Shutter (Wipe)

A black screen moves in from the top and bottom, closing over the image like a shutter, or a new image pushes open the black screen vertically from the center.

#### **SLIDE** Slide (Wipe)

A black screen moves in from the left to gradually cover the image, or a new image moves in from right to left.

### NOTES:

- Pressing and holding the Recording Start/Stop Button allows you to record a black blank screen or a mosaic pattern if Mosaic Fader is selected.
- The screen becomes slightly reddish when the Fade/Wipe is used with Sepia (☞ pg. 23).
- With the Electronic fog filter mode (☞ pg. 23) engaged, the image fades in/out or wipes in/out to a white screen.

### NOTE (for Fade/Wipe, Wide, Super LoLux, Instant Titles and Picture Stabilizer):

When the Select Dial is turned to AUTO LOCK, the above functions will be set to the Factory settings (Fade/Wipe-standby : "OFF", Wide mode : off, Super LoLux : "MAX", Instant Title : off, Picture Stabilizer : off). Then when the Select Dial is returned to any position except AUTO LOCK, the above functions return to the settings you selected before turning it to AUTO LOCK. However, if the function is switched during AUTO LOCK, the selected mode will be set and will remain unchanged even when the Select Dial is turned to any position except AUTO LOCK.



Viewfinder

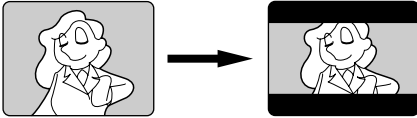

Wide mode

## Wide

This feature allows you to record black bars at the top and bottom of the screen to produce a cinema-like "wide-screen" effect.

### 1 ENGAGE WIDE MODE

Press **WIDE**.

- To restore normal screen, press **WIDE** again.

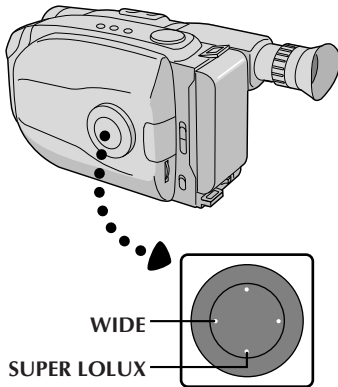

Viewfinder

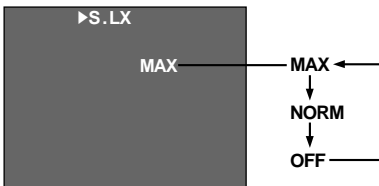

↓ After 2 sec.

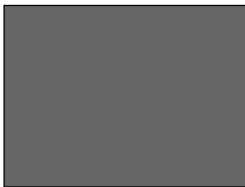

## Super LoLux(Gain Up)

Bright, natural recordings can be taken even in areas with low or poor lighting.

### 1 SELECT SUPER LOLUX MODE

Press **SUPER LOLUX** repeatedly to cycle through the modes as shown at left. Once the desired mode appears, it is engaged.

- The mode's name is displayed for approx. 2 seconds, then disappears.

- MAX** : To record a subject in a dark lit environment. When it is more convenient to shoot the subject with a brighter image even if the picture becomes slightly coarse.
- NORM** : To record a subject in a dimly lit environment. When it is more convenient to shoot with a less coarse picture although the subject becomes slightly dark. This setting is suitable for measuring sensitivity conforming to EIA-639 (EIA\* Standard for Low Light Sensitivity Measurement).
- \*EIA : Electronic Industries Association
- OFF** : Allows you to shoot dark scenes with no picture brightness adjustment.

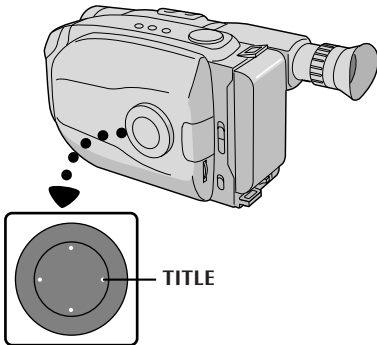
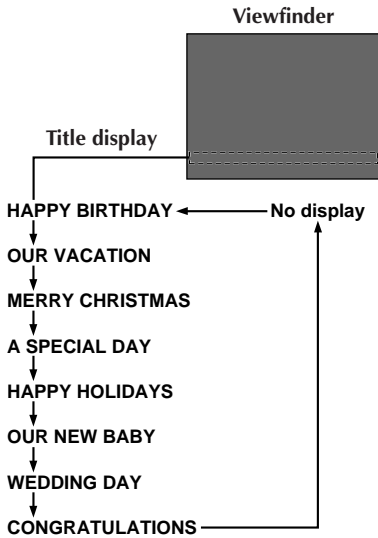

## Instant Titles

The camcorder has eight preset titles in memory. You can superimpose one of them above a previously stored title as shown in the illustration to the left.

Instant Titles can be displayed not only in English but also in French, Spanish and Portuguese. Change the setting in TITLE LANG. in the Menu screen. (☞ pg. 27, 29).

# 1

### SELECT PRESET TITLE

Press **TITLE** repeatedly to cycle through the preset titles until the desired title is displayed.

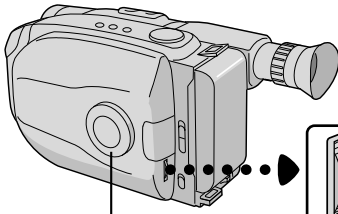

Select Dial

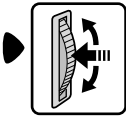

MENU Jog Dial

## Viewfinder

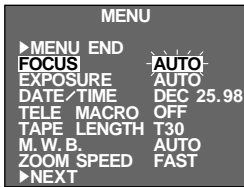

## Menu Screen 1



## Menu Screen 2

Setting Menu  
(ex. TITLE LANG.)

## Normal Screen

## Using Menu For Detailed Adjustment

This camcorder is equipped with an easy-to-use, on-screen menu system that simplifies many of the more detailed camcorder settings.

## 1 ACCESS MENU SCREEN

Turn the Select Dial to any position except AUTO LOCK, then press the MENU Jog Dial. The Menu Screen appears.

## 2 SELECT FUNCTION

Rotate the MENU Jog Dial to place the highlight bar on the desired function.

- When the highlight bar reaches the bottom of Menu Screen 1, Menu Screen 2 is automatically displayed. When the highlight bar reaches the top of Menu Screen 2, Menu Screen 1 is automatically displayed.
- If the setting you want can't be found in the Menu Screen, place the highlight bar on "MENU END", then go to step 5.

## 3 MAKE SETTING

Press the MENU Jog Dial. The setting menu of the selected function appears. The setting procedure depends on the function you select.

*If you select "FOCUS", "EXPOSURE", or "DATE/TIME" . . .*

... see respective pages (FOCUS: [pg. 30, 31](#), EXPOSURE: [pg. 32](#), DATE/TIME: [pg. 11](#)).

*If you select "JLIP ID NO." . . .*

... press the MENU Jog Dial so that the number blinks, then rotate it until the desired number appears, and press it. Then rotate the MENU Jog Dial to move the highlight bar to "EXIT".

*If you select any other functions . . .*

... rotate the MENU Jog Dial to move the highlight bar to the desired setting.

- If you decide you want to return to the previous setting, rotate the MENU Jog Dial to move the highlight bar to "EXIT".

## 4 END SETTING

Press the MENU Jog Dial. The Menu Screen reappears and the highlight bar is on "MENU END".



## 5 CLOSE MENU

Press the MENU Jog Dial. The normal screen reappears.

## NOTE:

The menu function except "FOCUS" and "EXPOSURE" are not available while in the Record mode.

## Menu Screen Explanations

<b>FOCUS</b>	<b>AUTO</b>	Adjusts focus automatically.
	<b>MANU</b>	Allows you to adjust focus manually (☞ pg. 30, 31).
<b>EXPOSURE</b>	<b>AUTO</b>	Adjusts exposure automatically.
	<b>MANU</b>	Allows you to adjust exposure manually (☞ pg. 32).
<b>DATE/TIME</b>	Allows you to set the current date and time (☞ pg. 11).	
<b>TELE MACRO</b>	<b>OFF</b>	Usually the distance to a subject where the lens is in focus depends on the zoom magnification. Unless there is a distance more than 1 m (3.3 ft.) to the subject, the lens is out of focus at the maximum telephoto setting. When set to "ON", you can shoot a subject as large as possible at a distance of approx. 60 cm (2 ft.). • Depending on the zoom position, the lens may go out of focus.
	<b>ON</b>	
<b>TAPE LENGTH</b>	Allows you to set the tape length depending on the tape used (☞ pg. 12).	
<b>M.W.B.</b>	<b>AUTO</b>	This camcorder's Automatic Color Temperature system senses the color temperature of the ambient lighting for automatic white balance adjustment. However, precise color adjustment is not possible under the following conditions: • When an object is in various shades of the same color. • When a predominantly red or brown object is being shot outdoors. In these cases, use the camcorder's built-in preset filters for white balance adjustment (☞ pg. 33).
	 : <b>FINE</b>	
	 : <b>CLOUD</b>	
	 : <b>HALOGEN</b>	
	<b>MWB</b>	
<b>ZOOM SPEED</b>	<b>FAST</b>	Allows you to set the zooming speed (☞ pg. 18).
	<b>SLOW</b>	

<b>REC TIME</b>	This feature allows you to set the parameters for Animation and Time-Lapse recording (☞ pg. 35).	
<b>INT. TIME</b>	This feature allows you to set the parameters for Self-Timer (☞ pg. 34) and Time-Lapse recording (☞ pg. 35).	
<b>TALLY LAMP</b>	<b>ON</b>	The tally lamp comes on to signal the start of recording.
	<b>OFF</b>	The tally lamp remains off at all times.
<b>TITLE LANG.</b>	Allows you to select the language (ENGLISH, FRENCH, SPANISH or PORTUGUESE) of Instant Titles (☞ pg. 26)	
<b>D. ZOOM</b>	<b>ON</b>	Allows you to use the Digital Zoom. By digitally processing and magnifying images, zooming is possible from 22 times (the optical zoom limit), to a maximum of 44 times digital magnification.
	<b>OFF</b>	Digital Zoom is not available. Only optical zoom (maximum 22x magnification) can function. When set to "OFF" during Digital Zoom, zoom magnification changes to 22x.
<b>COLOR BAR</b>	<b>OFF</b>	Does not display color bars. Normal screen is recorded.
	<b>ON</b>	Makes the normal screen disappear, then displays color bars. By recording color bars at the beginning or end of a tape, an effect similar to professional productions can be given to your tape. <b>NOTE:</b> While the color bars are displayed, the camcorder's other functions are disabled.
<b>JLIP ID NO.</b>	This number is necessary when connecting the camcorder to a device such as a computer using the J terminal (JLIP). The numbers range from 01 to 99. Factory setting is 07.	
<b>DEMO MODE</b>	<b>OFF</b>	Automatic demonstration will not take place.
	<b>ON</b>	Demonstrates certain functions such as Fade/Wipe, Instant Titles etc. When "DEMO MODE" is set to "ON" and the Menu Screen is closed, demonstration starts. <b>NOTES:</b> <ul style="list-style-type: none"> <li>● When a tape whose Erase Protection tab is in the position that allows recording is loaded in the camcorder, demonstration is not available.</li> <li>● By turning off the camcorder or inserting a tape whose Erase Protection tab is in the position that allows recording into it, "DEMO MODE" is set to "OFF" automatically.</li> <li>● During demonstration, all functions except zoom are disabled.</li> </ul>

 = Factory setting and when the Select Dial is set to AUTO LOCK



Focus detection zone

## Focusing

### Auto Focus

The camcorder's Full Range AF system offers continuous shooting ability from close-up to infinity. However, correct focus may not be obtainable in the situations listed below (in these cases use manual focusing):

- When two subjects overlap in the same scene.
- When illumination is low.\*
- When the subject has no contrast (difference in brightness and darkness), such as a flat, one-color wall, or a clear, blue sky.\*
- When a dark object is barely visible.\*
- When the scene contains minute patterns or identical patterns that are regularly repeated.
- When the scene is affected by sunbeams or light reflecting off the surface of a body of water.
- When shooting a scene with a high-contrast background.

\* The low-contrast warning “▲▲” appears.

### NOTES:

- If the lens is smeared or blurred, accurate focusing is not possible. Keep the lens clean, wiping with a piece of soft cloth if it gets dirty. When condensation occurs, wipe with a soft cloth or wait for it to dry naturally.
- When shooting a subject close to the lens, zoom-out first (☞ pg. 18). If zoomed-in in the auto focus mode, the camcorder could automatically zoom out depending on the distance between the camcorder and the subject. When Tele Macro (☞ pg. 28) is activated, the camcorder will not zoom out automatically.

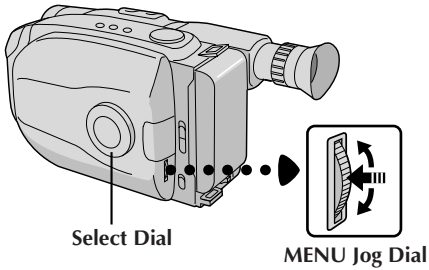

Select Dial

MENU Jog Dial

Viewfinder

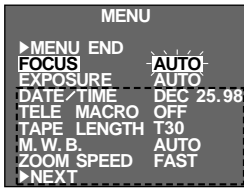

Menu Screen

No indication during recording



Focus Menu Screen

No indication during recording

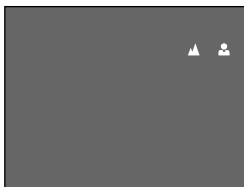

Manual Focus Screen

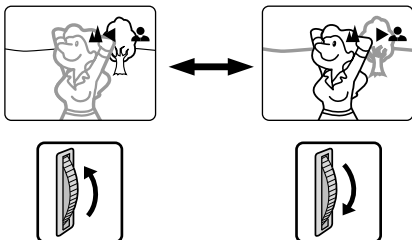

## Manual Focus

### NOTE:

You should already have made the necessary viewfinder adjustments (☞ pg. 14). If you haven't, do so before continuing.

### 1 ACCESS MENU SCREEN

Turn the Select Dial to any position except AUTO LOCK, then press the MENU Jog Dial. The Menu Screen appears, and the highlight bar is placed on "FOCUS".

### 2 ACCESS FOCUS MENU SCREEN

Press the MENU Jog Dial.

### 3 ACCESS MANUAL FOCUS

Rotate the MENU Jog Dial to move the highlight bar to "MANU", then press it. "▲" and "●" appear. The focus is locked at this point.

### 4 ADJUST FOCUS

#### To farther subject . . .

Rotate the MENU Jog Dial upward. "◀" appears and blinks.

Go to step 5.

#### To nearer subject . . .

Rotate the MENU Jog Dial downward. "▶" appears and blinks.

Go to step 5.

### 5 END ADJUSTMENT OF FOCUS

Press the MENU Jog Dial. The Menu Screen reappears and the highlight bar is placed on "MENU END".

### 6 CLOSE MENU

Press the MENU Jog Dial. The Menu Screen disappears and "▲●" reappears to indicate the focus is locked.

### NOTES:

- To return to Auto Focus, select "AUTO" in step 3.
- To re-adjust Manual Focus, repeat the procedure from step 1.
- Be sure to focus the lens in the maximum telephoto position when you use the Manual Focus mode. If you focus in on a certain subject in the wide-angle position, sharply focused images cannot be obtained when zoomed up because the depth-of-field is reduced at longer focal lengths.
- When the focus level cannot be adjusted any farther or closer, "▲" or "●" will blink.

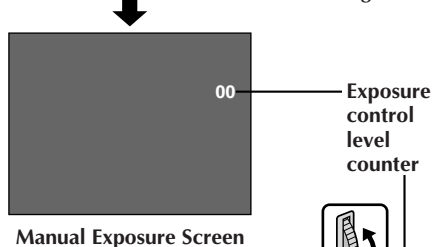
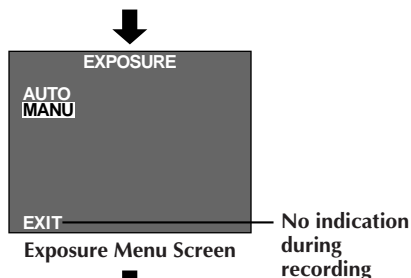
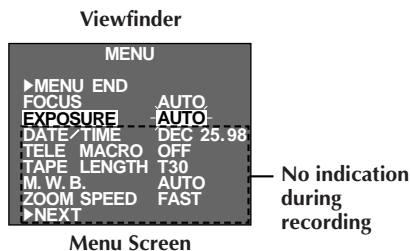
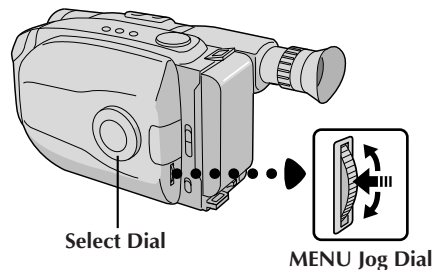

To brighten the image

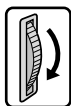

To darken the image

## Exposure Control

This feature automatically adjusts the iris for the best available picture quality, but you can override and make the adjustment manually.

- 1 ACCESS MENU SCREEN**  
Turn the Select Dial to any position except AUTO LOCK, then press the MENU Jog Dial. The Menu Screen appears.
- 2 ACCESS EXPOSURE MENU SCREEN**  
Rotate the MENU Jog Dial to move the highlight bar to "EXPOSURE" and press it.
- 3 ACCESS MANUAL EXPOSURE**  
Rotate the MENU Jog Dial to move the highlight bar to "MANU", then press it. "00" (exposure control level counter) appears.
- 4 ADJUST EXPOSURE**
  - 4 To brighten the image . . .**  
Rotate the MENU Jog Dial upward. The exposure control level counter increases (maximum +06). Go to step 5.
  - To darken the image . . .**  
Rotate the MENU Jog Dial downward. The exposure control level counter decreases (maximum -06). Go to step 5.
- 5 END ADJUSTMENT OF EXPOSURE**  
Press the MENU Jog Dial. The Menu Screen reappears and the highlight bar is placed on "MENU END".
- 6 CLOSE MENU**  
Press the MENU Jog Dial. The Menu Screen disappears and the exposure control level counter reappears to indicate the exposure is adjusted.

### NOTES:

- To return to the factory setting, select "AUTO" in step 3.
- To re-adjust exposure, repeat the procedure from step 1.



## Viewfinder

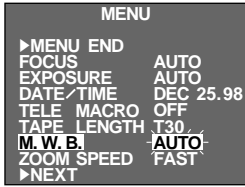

Menu Screen

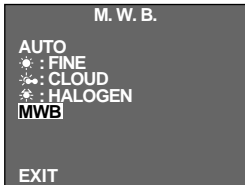
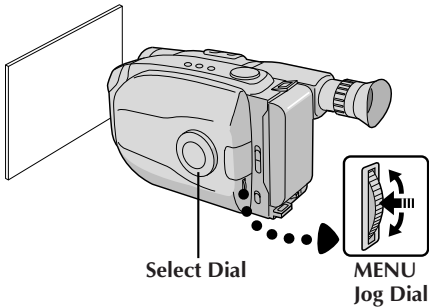
M.W.B.  
Menu Screen

## Manual White Balance Adjustment (M.W.B.)

The white balance is usually adjusted automatically. However, the more advanced camcorder operator would prefer to control this function manually and achieve a more professional color/tint reproduction.

### ACCESS MENU SCREEN

- 1 Turn the Select Dial to any position except AUTO LOCK, then press the MENU Jog Dial. The Menu Screen appears.

### ACCESS WHITE BALANCE MENU SCREEN

- 2 Rotate the MENU Jog Dial to move the highlight bar to "M.W.B.", then press it.

### SELECT WHITE BALANCE

- 3 Rotate the MENU Jog Dial to move the highlight bar to the required white balance.

"AUTO" .....	Automatic adjustment
"☀️" : FINE" .....	Outdoors on sunny day
"☁️" : CLOUD" .....	Outdoors on cloudy day
"💡" : HALOGEN" ...	Light source is halogen or tungsten lamp
"MWB" .....	When using a personal White Balance Setting stored in memory (see below.)

### CLOSE MENU

- 4 Press the MENU Jog Dial. The Menu Screen reappears. Then press the MENU Jog Dial again to exit the Menu Screen.

## MWB

MWB sets the color temperature for the subject's light source so you can shoot with natural colors that are unaffected by surroundings, even when there are multiple subjects with different color temperatures.

### PREPARE WHITE OBJECT

- 1 Point the camcorder at a white, flat object such as a sheet of white paper.

### SELECT MWB

- 2 Follow step 1 through 3 of the above, select "MWB".

### MEMORIZE WHITE BALANCE

- 3 Press the MENU Jog Dial until "MWB" begins blinking. "MWB" blinks while the white balance is being stored in memory, then the Menu Screen reappears when memorization is complete.

### CLOSE MENU

- 4 Press the MENU Jog Dial.

## NOTES:

- To switch to automatic white balance adjustment, set the M.W.B. in the Menu Screen to "AUTO", or turn the Select Dial to "AUTO LOCK".
- Re-adjust the White Balance when the lighting has changed, when the camcorder has been turned off and on again, or when the Select Dial's position has been changed.
- When adjusted by putting colored paper in front of the subject in step 1 of "MWB", this unit makes its color temperature standard for automatic white balance. So you can enjoy shooting with different colors. For example, when adjusting with red, blue or yellow colors, the image becomes the color which approximates to green, orange or purple respectively.
- It is helpful to connect your camcorder to a color monitor when adjusting the white balance (☞ pg. 37).

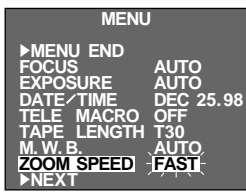
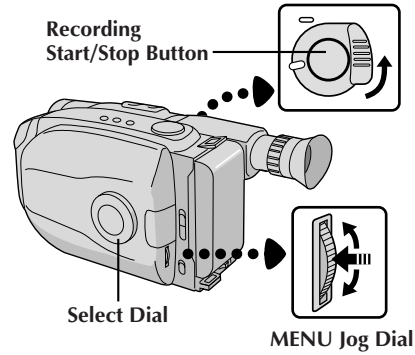

Menu Screen

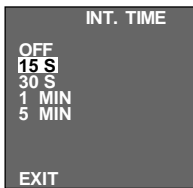
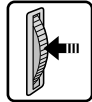

INT. TIME Menu

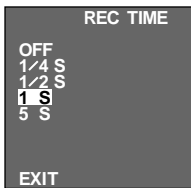

REC TIME Menu

INT. TIME Indicator

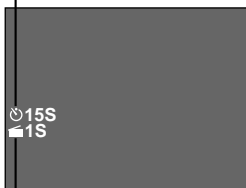

REC TIME Indicator

INT. TIME and REC TIME indications on the normal screen

## Self-Timer

You can set the delay between pressing the Recording Start/Stop Button and the actual start of recording. If you secure the camcorder, you (or whomever is operating the camcorder) can enter the scene before recording starts.

### NOTE:

Make sure the camcorder is in the Record-Standby mode before performing the following steps.

## ACCESS MENU SCREEN

- 1 Turn the Select Dial to any position except AUTO LOCK, then press the MENU Jog Dial.

## ACCESS INT. TIME MENU SCREEN

- 2 Rotate the MENU Jog Dial to move the highlight bar to "INT. TIME", then press the MENU Jog Dial.

## SET INTERVAL TIME

- 3 Rotate the MENU Jog Dial to move the highlight bar to the desired time, then press the MENU Jog Dial. The Menu Screen reappears and the highlight bar is placed on "MENU END".

## CLOSE MENU

- 4 Press the MENU Jog Dial.

## START DELAYED RECORDING

- 5 Press the Recording Start/Stop Button. When the selected time has elapsed, recording begins automatically.

### To Cancel Self-Timer . . .

... Before the recording begins, press the Recording Start/Stop Button to display "≡PAUSE≡", then set "INT. TIME" in the Menu Screen to "OFF".

## Animation

Give stationary scenes or objects an illusion of movement. This function allows you to shoot a series of pictures, each slightly different, of the same object for a brief period of time.

### NOTE:

Make sure the camcorder is in the Record-Standby mode and the recording mode is set to "SP" before performing the following steps.

- 1** ACCESS MENU SCREEN  
Turn the Select Dial to any position except AUTO LOCK, then press MENU Jog Dial.
- 2** SET RECORDING TIME  
Rotate the MENU Jog Dial to move the highlight bar to "REC TIME", then press the MENU Jog Dial. The REC TIME Menu appears. Rotate the MENU Jog Dial to move the highlight bar to the desired time, then press the MENU Jog Dial. The Menu Screen reappears. Press the MENU Jog Dial again to exit the Menu Screen.
- 3** START RECORDING  
Press the Recording Start/Stop Button after focusing on the subject. The recording stops automatically after the selected period of time.
- 4** ASSEMBLE SERIES OF PICTURES  
Repeat step 3 for the desired number of pictures.
- 5** RELEASE ANIMATION MODE  
Set "REC TIME" in the Menu screen to "OFF".

### NOTES:

- For best results, make sure the camcorder is secured when shooting in Animation or Time-Lapse mode.
- Fade- or Wipe-in/out cannot be performed during Animation or Time-Lapse shooting.
- Before performing other operations following Animation or Time-Lapse recording, make sure the Animation or Time-Lapse mode is deactivated.
- Self-Timer, Animation and Time-Lapse are canceled when the power is shut off or when the cassette is ejected.

## Time-Lapse

You can record sequentially at preset time spans. Leaving the camcorder aimed at a specific subject, you can record subtle changes over an extended period of time.

### NOTE:

Make sure the camcorder is in the Record-Standby mode and the recording mode is set to "SP" before performing the following steps.

- 1** ACCESS MENU SCREEN  
Turn the Select Dial to any position except AUTO LOCK, then press MENU Jog Dial.
- 2** SET INTERVAL BETWEEN RECORDINGS  
Rotate the MENU Jog Dial to move the highlight bar to "INT. TIME", then press the MENU Jog Dial. The INT. TIME Menu appears. Rotate the MENU Jog Dial to move the highlight bar to the desired time, then press the MENU Jog Dial. The Menu Screen reappears.
- 3** SET RECORDING TIME  
Rotate the MENU Jog Dial to move the highlight bar to "REC TIME", then press the MENU Jog Dial. The REC TIME Menu appears. Rotate the MENU Jog Dial to move the highlight bar to the desired time, then press the MENU Jog Dial. The Menu Screen reappears. Press the MENU Jog Dial again to exit the Menu Screen.
- 4** START TIME-LAPSE RECORDING  
Press the Recording Start/Stop Button. Recording and intervals alternate automatically.
- 5** RELEASE TIME-LAPSE MODE  
To release when "≡PAUSE≡" is displayed, set "REC TIME" and "INT. TIME" in the Menu Screen to "OFF". To release when "≡PAUSE≡" and "▶▶▶" are not displayed, press the Recording Start/Stop Button to display "≡PAUSE≡", then set "REC TIME" and "INT. TIME" in the Menu Screen to "OFF".

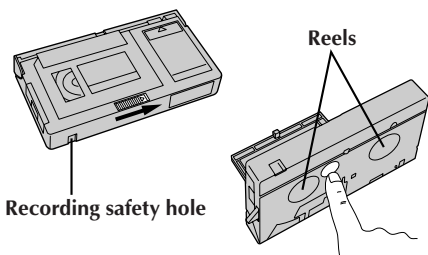
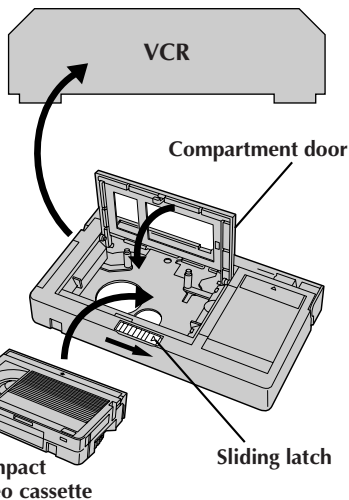
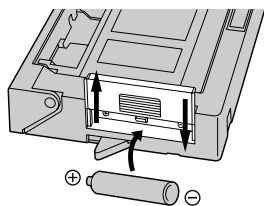

## Cassette Adapter (VHS Playpak)

Use this to play back a VHS-C video cassette recorded with this camcorder. It is fully compatible with any VHS video cassette recorder. The C-P7U adapter is battery powered and automatically performs tape loading and unloading.

### 1 INSERT BATTERY

Slide the battery cover up to remove it, and install one "AA(R6)" size battery as shown in the illustration at left. Then reattach the cover.

### 2 INSERT CASSETTE IN ADAPTER

Slide the latch to open the adapter compartment door, then insert the cassette and close the compartment door.

### 3 PLAY BACK ON CONNECTED VCR

Load the cassette adapter into the VCR and play the tape back as you would any other.

### 4 REMOVE CASSETTE FROM ADAPTER

Slide the latch and the compartment door opens automatically. This may take around 10 seconds. Do not attempt to force the adapter open. Then insert your finger in the hole on the underside of the adapter as shown in the illustration at left, push up and remove the cassette.

## NOTES:

- During tape loading and unloading, do not touch the reels for safety and tape protection.
- During special-effect playback (slow motion, still frame, etc.), the picture may vibrate or noise bars may appear on the screen.
- To record on a VCR using a compact cassette and the adapter, cover the adapter's recording safety hole with adhesive tape.

When connecting the cables, open the jack cover.

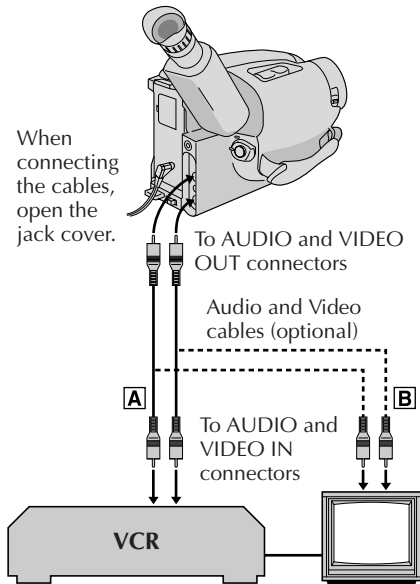

There are three basic types of connections. When making the connections, refer also to your VCR and TV instruction manuals.

## Connection To A VCR **A** (Editing, Dubbing and Playback)

### NOTE:

Use the optional Audio and Video cables.

### 1 CONNECT CAMCORDER TO VCR

As shown in the illustration at left, connect the Audio and Video cables between the AUDIO and VIDEO OUT connectors on the camcorder and those on the VCR.

### 2 SUPPLY POWER

Turn on the camcorder, the VCR and the TV.

### 3 SELECT MODE

Set the VCR to its AUX input mode, and set the TV to its VIDEO mode.

## Connection To A TV With A/V Input Connectors **B** (Playback ONLY)

### NOTE:

Use the optional Audio and Video cables.

### 1 CONNECT CAMCORDER TO TV

As shown in the illustration at left, connect the Audio and Video cables between the AUDIO and VIDEO OUT connectors on the camcorder and those on the TV.

### 2 SELECT MODE

Set the TV to its VIDEO or AV mode (as specified in its instructions).

Antenna

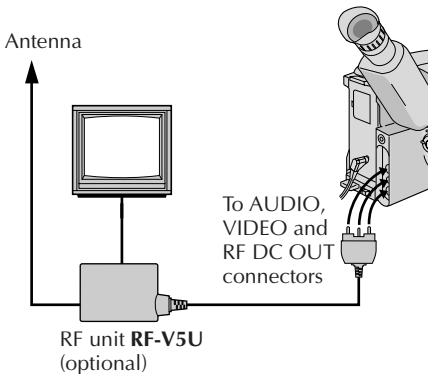

### NOTES:

- It is recommended to use the AC Power Adapter/Charger as the power supply instead of the battery pack.
- To monitor the picture and sound from the camcorder without inserting a tape, set the camcorder's Power Switch to "CAMERA", then set your TV to the appropriate input mode.
- If you have a TV or speakers that are not specially shielded, do not place the speakers adjacent to the TV as interference will occur in the camcorder playback picture.

## Connection To A TV With NO A/V Input Connectors (Playback ONLY)

### NOTE:

Use the optional RF-V5U RF unit.

\* Refer to the RF-V5U instruction manual for connection procedure.

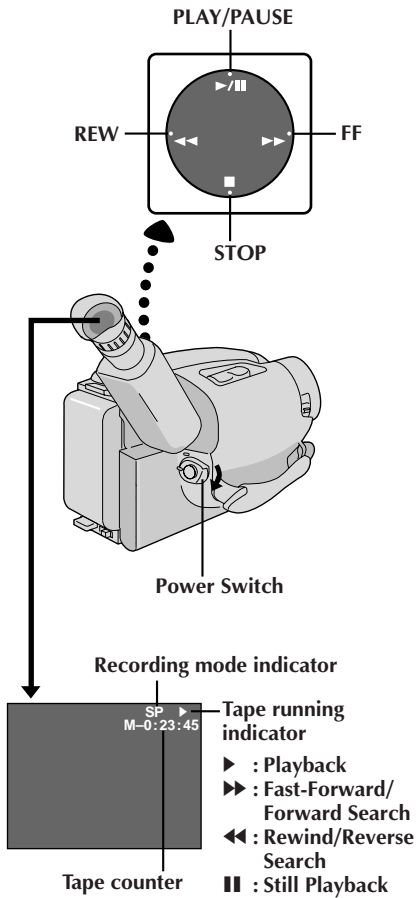

## 1 LOAD A CASSETTE

Slide **EJECT** to open the cassette holder, then insert the cassette with the label facing out. Press **PUSH** to ensure the holder is closed and locked.

## 2 SELECT MODE

Set the Power Switch to "PLAY". The power indicator lights.

## 3 PLAY BACK

Press **PLAY/PAUSE**. The playback picture appears.

## 4 STOP PLAYBACK

Press **STOP**.

## Rewind or Fast-forward the tape

Press **REW** to rewind, or **FF** to fast-forward the tape during Stop mode.

## NOTE:

*The camcorder shuts off automatically after about 5 minutes in Stop mode. To turn on again, set the Power Switch to "POWER OFF", then to "PLAY".*

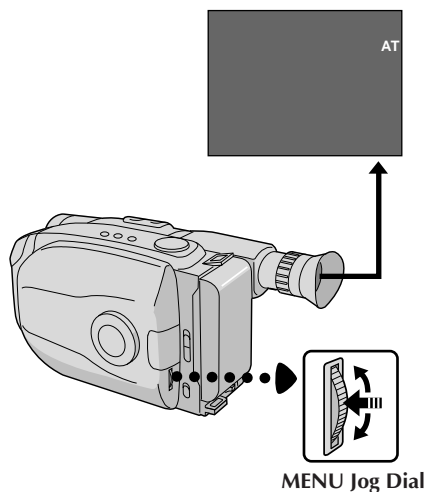

## Tracking

This function can be used to eliminate noise bars that appear on-screen during playback. Initial setting is Auto Tracking. Manual Tracking is also available.

### 1 ACTIVATE MANUAL TRACKING

Press the MENU Jog Dial during playback mode. Keep rotating it until noise bars disappear.

- To return to Auto Tracking, press the MENU Jog Dial. "AT" blinks. When Auto Tracking finishes, the indication disappears.

### NOTES:

- When noise bars appear during playback, the camcorder enters the Auto Tracking mode and "AT" is displayed.
- Manual Tracking may not work with tapes recorded on other VCRs or camcorders.

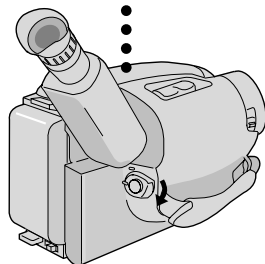
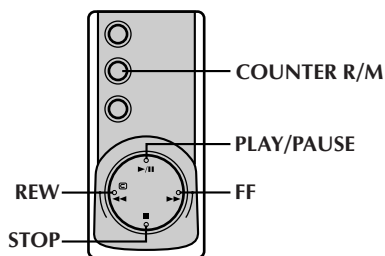

<p><b>FEATURE:</b></p> <p><b>PURPOSE:</b></p> <p><b>OPERATION:</b></p> <p><b>NOTE:</b></p>	<p><b>Still Playback</b></p> <p>To pause during playback.</p> <ol style="list-style-type: none"> <li>1) Press <b>PLAY/PAUSE</b> during playback.</li> <li>2) To resume normal playback, press <b>PLAY/PAUSE</b> again.</li> </ol> <p><i>Noise bars appear and pictures may become monochrome during Still Playback. This is normal.</i></p>
<p><b>FEATURE:</b></p> <p><b>PURPOSE:</b></p> <p><b>OPERATION:</b></p> <p><b>NOTE:</b></p>	<p><b>Shuttle Search</b></p> <p>To allow high-speed search in either direction.</p> <p><b>Forward Search</b></p> <ol style="list-style-type: none"> <li>1) Press <b>FF</b> during playback.</li> </ol> <p><b>Reverse Search</b></p> <ol style="list-style-type: none"> <li>1) Press <b>REW</b> during playback.</li> </ol> <p><i>Noise bars appear and pictures may become monochrome or darken in Shuttle Search. This is normal.</i></p>
<p><b>FEATURE:</b></p> <p><b>PURPOSE:</b></p> <p><b>OPERATION:</b></p> <p><b>NOTES:</b></p>	<p><b>Counter Memory Function</b></p> <p>To make it easier to locate a specific tape segment.</p> <ol style="list-style-type: none"> <li>1) Press <b>COUNTER R/M</b> and hold for more than 1 second. The counter resets to "0:00:00".</li> <li>2) Press <b>COUNTER R/M</b> for less than 1 second. "M" appears.</li> <li>3) After recording or playback, press <b>STOP</b>, then <b>REW</b>. The tape automatically stops at or close to 0:00:00.</li> <li>4) Press <b>PLAY/PAUSE</b> to start playback.</li> </ol> <ul style="list-style-type: none"> <li>• <i>The counter memory functions in the Fast-Forward and Rewind modes.</i></li> <li>• <i>To disable Counter Memory Function, press <b>COUNTER R/M</b> for less than 1 second so the "M" disappears.</i></li> </ul>



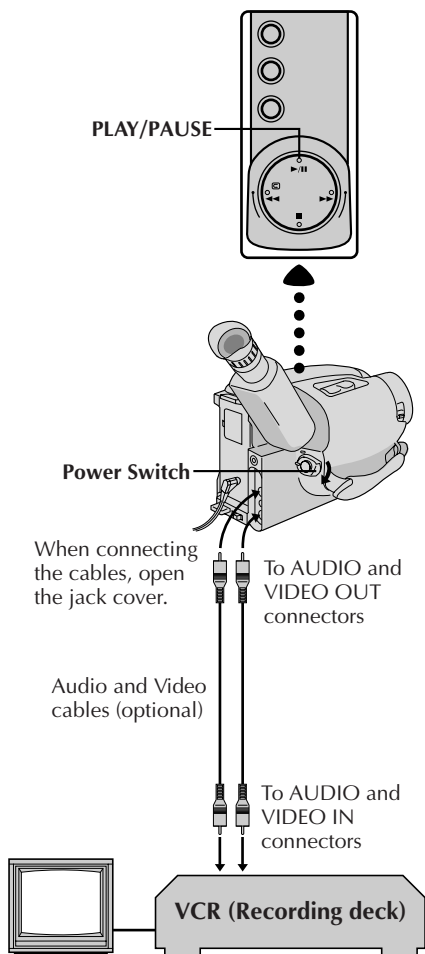

## Tape Dubbing

### CONNECT EQUIPMENT

- 1 Following the illustration at left, connect the camcorder and the VCR.

### PREPARE FOR DUBBING

- 2 Set the camcorder's Power Switch to "PLAY", turn on the VCR's power, and insert the appropriate cassettes in the camcorder and the VCR.

### SELECT VCR MODE

- 3 Engage the VCR's AUX and Record-Pause modes.

### FIND EDIT-IN POINT

- 4 Engage the camcorder's Play mode to find a spot just before the edit-in point. Once it's reached, press **PAUSE** on the camcorder.

### START EDITING

- 5 Press **PLAY** on the camcorder and engage the VCR's Record mode.

### STOP EDITING TEMPORARILY

- 6 Engage the VCR's Record-Pause mode and press **PAUSE** on the camcorder.

### EDIT MORE SEGMENTS

- 7 Repeat steps 4 through 6 for additional editing, then stop the VCR and camcorder when finished.

The Full-Function Remote Control Unit can operate this camcorder from a distance as well as the basic operations (PLAY, STOP, PAUSE, FF, and REW) of your VCR. This remote control unit makes additional recording functions possible.

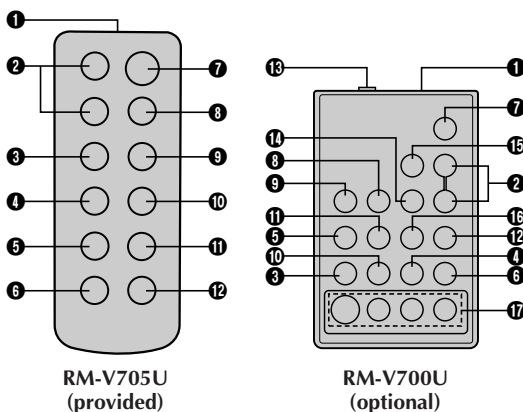
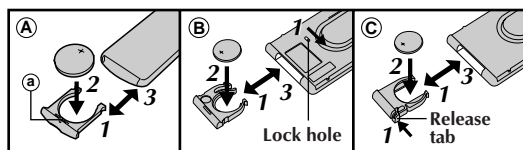

RM-V705U  
(provided)

RM-V700U  
(optional)

## INSTALLING THE BATTERY

### PULL OUT BATTERY HOLDER

- 1** **Type A** : Pull out by inserting a pointed instrument into slot ②.
- Type B** : Pull out while sliding the lock hole.
- Type C** : Pinch the release tab and pull out.

### INSERT BATTERY

- 2** Making sure the plus (+) side is up, insert the lithium battery (CR2025)\* into the battery holder.

### REPLACE BATTERY HOLDER

- 3** Insert the battery holder into the remote control unit, and push the holder until it clicks into place.
- \* Read the caution concerning lithium batteries (☞ pg. 2).

BUTTONS	FUNCTIONS	
	With the camcorder's power switch set to "CAMERA".	With the camcorder's power switch set to "PLAY".
① Infrared beam transmitting window	Transmits the beam signal.	
② ZOOM (T/W) Buttons	Zoom in/out (☞ pg. 18)	—
③ PLAY Button	—	Playback start (☞ pg. 38)
④ STOP Button	—	Stop (☞ pg. 38)
⑤ REW Button	Retake (rewind)/Quick Review (☞ pg. 19)	Rew/Rew Shuttle Search (☞ pg. 38, 40)
⑥ INSERT Button	—	Insert Editing (☞ pg. 48)
⑦ START/STOP Button	Functions same as the Recording Start/Stop button on the camcorder.	
⑧ INT. TIME Button	Self-Timer/Time-Lapse (☞ pg. 43)	—
⑨ REC TIME Button	Animation/Time-Lapse (☞ pg. 43)	—
⑩ PAUSE Button	—	Pause (☞ pg. 40)
⑪ FF Button	Retake (forward) (☞ pg. 19)	FF/FF Shuttle Search (☞ pg. 38, 40)
⑫ A.DUB Button	—	Audio dubbing (☞ pg. 49)
⑬ PAUSE IN Connector	—	☞ pg. 45
⑭ MBR SET Button	—	☞ pg. 44
⑮ VISS Button	Index Code marking (☞ pg. 43)	—
⑯ VCR CTL Button	—	☞ pg. 44
⑰ R.A.EDIT Buttons	—	☞ pg. 46

⑬ — ⑰ : RM-V700U only.

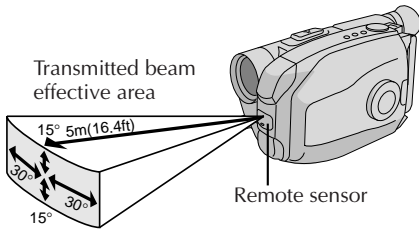

When using the remote control, be sure to point it at the remote sensor. The above illustration shows the approximate transmitted beam effective area for indoor use. The transmitted beam may not be effective or may cause incorrect operation outdoors or when the remote sensor is directly exposed to sunlight or powerful lighting.

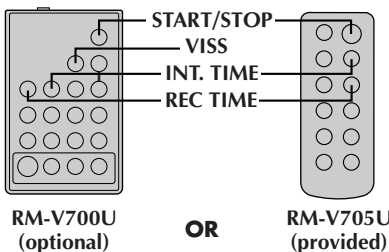
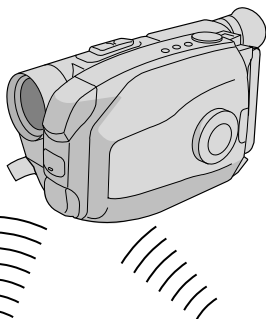
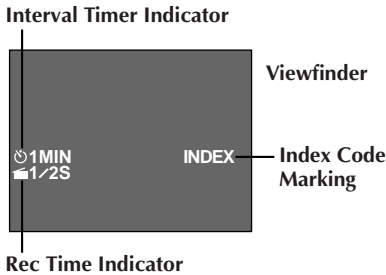

**FEATURE:**  
**PURPOSE:**

**OPERATION:**

**Self-Timer, Animation and Time-Lapse**

The remote control lets you set/release Interval Timer and Rec Time functions as well as the Menu Screen.

**Self-Timer**

**1) Set**  
Instead of performing steps 1 through 4 on pg. 34 ("Self-Timer"), press **INT. TIME** on the remote control. Each time **INT. TIME** is pressed, the Interval Timer indicator appears, changing in the following order: 15S, 30S, 1MIN, 5MIN and No indication (off).

**2) Release**  
Instead of setting "INT. TIME" to "OFF" in the Menu, press **INT. TIME** on the remote control until the Interval Timer indicator disappears.

**Animation**

**1) Set**  
Instead of performing steps 1 and 2 on pg. 35 ("Animation"), press **REC TIME** on the remote control. Each time **REC TIME** is pressed, the Rec Time indicator appears, changing in the following order: 1/4S, 1/2S, 1S, 5S and No indication (off).

**2) Release**  
Instead of using the Menu in step 5 on pg. 35, press **REC TIME** on the remote control until the Rec Time indicator disappears.

**Time-Lapse**

**1) Set**  
Instead of performing steps 1 through 3 on pg. 35 ("Time-Lapse"), press **INT. TIME** and **REC TIME** on the remote control. Each time **INT. TIME** is pressed, the Interval Timer indicator appears, changing in the following order: 15S, 30S, 1MIN, 5MIN and No indication (off). Each time **REC TIME** is pressed, the Rec Time indicator appears, changing in the following order: 1/4S, 1/2S, 1S, 5S and No indication (off).

**2) Release**  
Instead of using the Menu in step 5 on pg. 35, press **INT. TIME** and **REC TIME** on the remote control until the indicators disappear.

**NOTE:**

Also refer to pgs. 34 and 35.

**FEATURE:**  
**PURPOSE:**

**Index Code Marking (RM-V700U only)**

To give you automatic access to any selected point on a recording.

**OPERATION:**

**1) Press VISS** once to place the index code. "INDEX" blinks during marking.

**NOTE:**

If **VISS** is pressed during Record-Standby mode, the mark is placed where **START/STOP** is pressed.

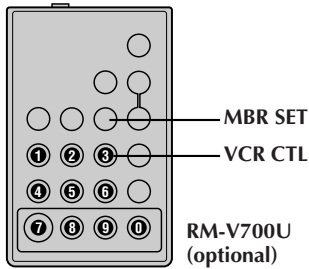

## VCR CODE LIST

VCR BRAND NAME	BUTTONS (A) (B)	VCR BRAND NAME	BUTTONS (A) (B)	
GE	1 1	PHILIPS	1 2	
	9 2		3 3	
	9 0		PANASONIC	1 3
	9 4	1 7		
HITACHI	6 6	1 1		
	6 3	9 4		
JVC	A 1 B 6 C 3	1 8	RCA	
		9 2		
		9 4		
MAGNAVOX	9 5	6 6		SANYO
	1 1	6 3		
	7 1	3 6		
	7 6	3 5		
MITSUBISHI	6 7	SHARP	1 5	
	6 8		1 0	
NEC	3 7	SONY	6 5	
	3 8		6 0	
PHILIPS	1 9		3 9	TOSHIBA
	9 5		3 1	
	1 1	ZENITH	6 9	
	9 4		6 1	
	9 1		1 6	
	9 6			

## Random Assemble Editing [R.A.Edit]

Create edited videos easily using your camcorder as the source player. You can select up to 8 “cuts” for automatic editing, in any order you like. R.A.Edit is more easily performed when the optional RM-V700U MBR (Multi-Brand Remote, [☞](#) pg. 42) is set to operate with your brand of VCR (see VCR CODE LIST), but can also be performed by operating the VCR manually. Before operation, make sure the lithium battery is installed in the remote control RM-V700U ([☞](#) pg. 42).

## SET REMOTE/VCR CODE

## SET REMOTE TO OPERATE VCR

- Turn off the power to the VCR and point the remote toward the VCR's infrared sensor. Then, referring to the VCR CODE LIST on the left, press and hold **MBR SET**, and press button (A) and then (B).

- The code is automatically set once you release the **MBR SET** button, and the VCR's power comes on.

## OPERATE VCR

- Make sure the VCR's power is on. Then, while holding **VCR CTL**, press the button on the remote for the desired function. The functions the remote can control are PLAY, STOP, PAUSE, FF, REW and VCR REC STBY (you don't need to press **VCR CTL** for this one).

*You're now ready to try Random Assemble Editing.*

## IMPORTANT

Although the MBR is compatible with JVC VCRs and those of many other makers, it may not work with yours or may offer limited functions.

## NOTES:

- If the VCR's power doesn't come on in step 1, try another code from the VCR CODE LIST.
- Some brands of VCR don't come on automatically. In this case, turn the power on manually and try step 2.
- If the RM-V700U is not able to control the VCR, use the controls on the VCR.

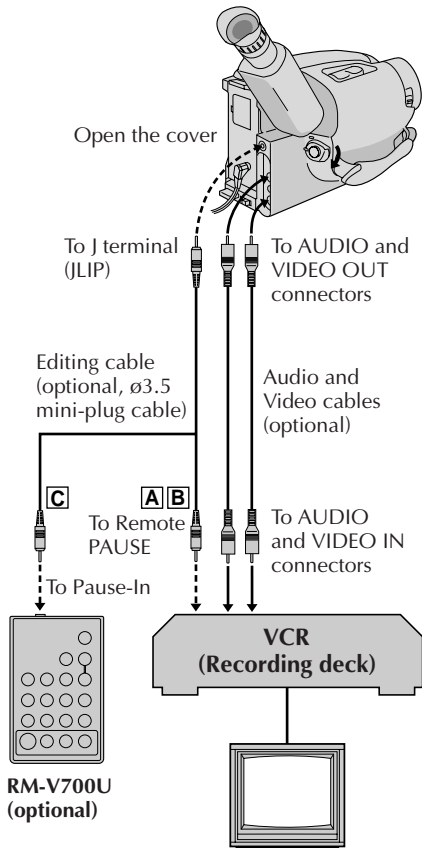

## MAKE CONNECTIONS

### CONNECT TO . . .

- 1** **A JVC VCR EQUIPPED WITH REMOTE PAUSE TERMINAL**  
Connect the editing cable to the Remote PAUSE terminal.
- B JVC VCR NOT EQUIPPED WITH REMOTE PAUSE TERMINAL BUT EQUIPPED WITH R.A. EDIT CONNECTOR**  
Connect the editing cable to the R.A.EDIT connector.
- C VCR OTHER THAN TYPE A OR B**  
Connect the editing cable to the RM-V700U's Pause-In jack.

### PREPARE CAMCORDER

- 2** Insert a recorded tape and set the Power Switch to "PLAY".

### PREPARE VCR

- 3** Turn the power on, insert a recordable tape and engage the AUX mode (refer to VCR's instructions).

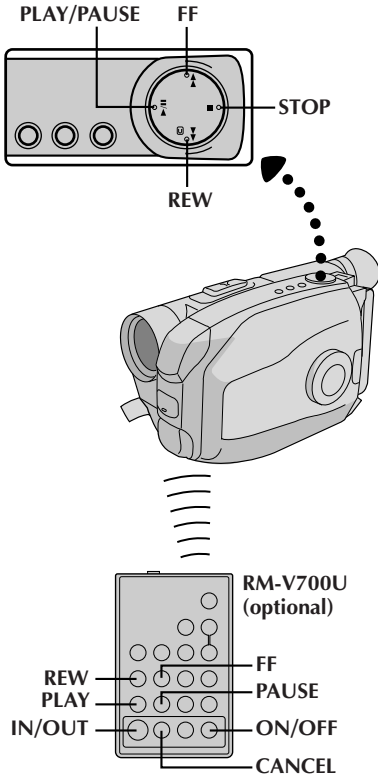

	IN	OUT
1	0:00:25	--:--:--
2		
3		
4		
5		
6		
7		
8		
COUNTER	0:00:25	
TOTAL	0:00:00	



	IN	OUT
1	0:00:25	0:01:05
2	0:03:18	0:03:31
3	0:02:33	0:02:53
4	0:04:11	--:--:--
5		
6		
7		
8		
COUNTER	0:04:11	
TOTAL	0:01:13	

## SELECT SCENES

### ACCESS R.A. EDIT COUNTER DISPLAY

- 1 Press **PLAY/PAUSE**, then press **ON/OFF** and the counter display appears in the viewfinder and the screen of the connected TV.

### REGISTER BEGINNING OF SCENE

- 2 Press **REW** or **FF** to locate the beginning of a scene you want, then press **IN/OUT** to register that point. The data appears under "IN" on the display.

### REGISTER END OF SCENE

- 3 Press **REW** or **FF** to locate the end of the scene and press **IN/OUT** to register it. The data appears under "OUT" on the display. The total time of the registered scene(s) is displayed at the bottom of the screen.

### REGISTER ADDITIONAL SCENES

- 4 Repeat steps 2 and 3 for each additional scene (as many as 8).

### MAKE CORRECTIONS

- 5 Press **CANCEL** during steps 2 and 3 to erase the most recently registered point.

## NOTES:

- There must be at least one second between an in-point and its corresponding out-point.
- To ensure correct operation, there should be at least 15 seconds between an out-point and the next in-point.
- Blank portions of tape cannot be registered as in-points or out-points.
- If it takes more than 5 minutes to search for an in-point, the VCR's Record-Pause mode is cancelled and editing doesn't take place.
- Pressing **ON/OFF** clears all in- and out-points from memory.
- Leave a small margin for error around each in-point to ensure the scene is recorded in its entirety.

## Original tape (camcorder)

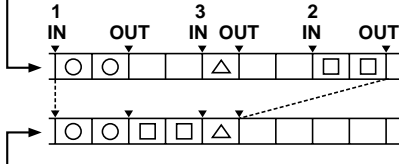

## Edited tape (VCR)

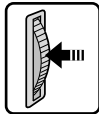
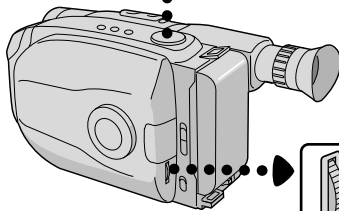
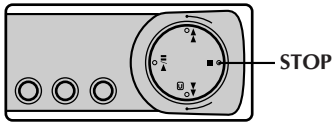

MENU Jog Dial

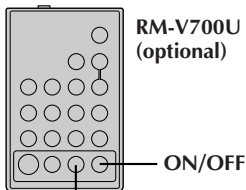

VCR REC STBY

## AUTOMATIC EDITING TO VCR

## ENGAGE VCR'S RECORD-PAUSE MODE

- 1 Point the remote control toward the VCR's infrared sensor and press **VCR REC STBY**, or manually engage the VCR's Record-Pause mode.

## BEGIN AUTOMATIC EDITING

- 2 Press the **MENU Jog Dial** on the camcorder, and the previously selected scenes are copied to the VCR in the specified order.

While editing, the R.A. Edit counter of the scene which is being copied is shown with a blinking highlight.

## END AUTOMATIC EDITING

- 3 When all selected scenes have been copied, the camcorder and VCR enter the still or pause mode. Press **STOP** on both units. To make the R.A. Edit counter display disappear, press **ON/OFF**.

- When finished editing, be sure to disconnect the editing cable and the audio/video cable.

## NOTES:

- If you performed step 1  on page 45 ("MAKE CONNECTIONS"), keep the remote control pointed at the VCR during editing.
- The on-screen display only appears while the camcorder searches for each scene.
- There may be noise at in- or out-points on the edited tape with certain VCRs.

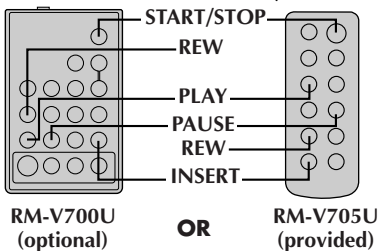
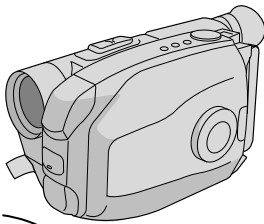
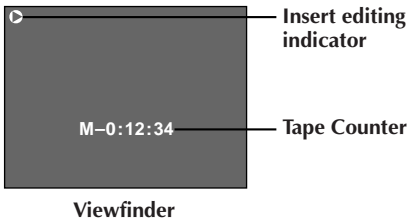
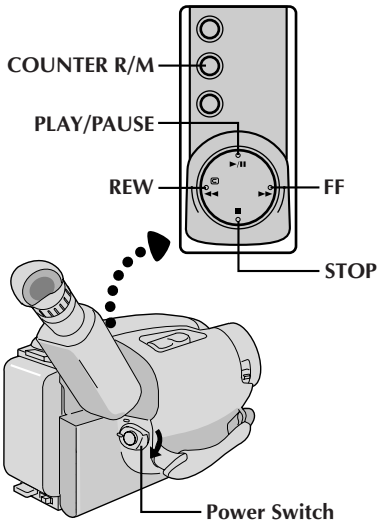

## Insert Editing

You can record a new scene into a previously recorded tape, replacing a section of the original recording with minimal picture distortion at the in- and out-points. The original audio remains unchanged.

### NOTE:

Use the RM-V705U or RM-V700U remote control unit to perform this procedure.

## SELECT MODE

- 1 Set the Power Switch to "PLAY".

## FIND EDIT-OUT POINT

- 2 Play back the tape, locate the point and press **PAUSE** on the camcorder or the remote control.

## RESET COUNTER

- 3 Press and hold **COUNTER R/M** for more than 1 second to reset the tape counter, then press again for less than 1 second and make sure "M" appears.

## FIND EDIT-IN POINT

- 4 Press **REW** to go a little beyond the beginning of the scene you want to replace, press **PLAY** to view the recorded tape, and press **PAUSE** exactly at the point where the new scene should start.

## ENGAGE INSERT EDITING MODE

- 5 Press and hold **INSERT**, and without releasing **INSERT**, press and release **PAUSE**. The Insert mode is engaged. When the scene the camcorder is aimed at appears on the screen, go to the next step.

## BEGIN INSERT EDITING

- 6 Press **START/STOP**. When the counter reaches "0:00:00", editing stops automatically and the camcorder enters the Insert-Pause mode.

## END INSERT EDITING

- 7 Press **STOP**.

### NOTES:

- After step 5, Retake (pg. 19) can be performed.
- The tape may stop slightly before or after the designated end point, and noise bars may appear. Neither indicates a defect in the unit.
- Only video signal is recorded in the Insert Editing mode.



Audio dubbing indicator



Viewfinder

Microphone

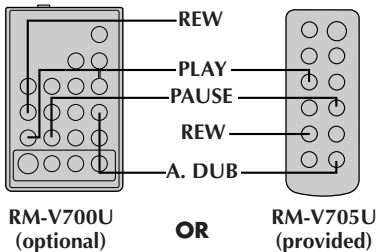
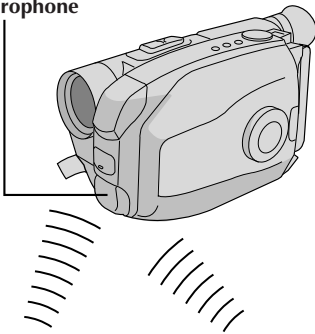
RM-V700U  
(optional)

OR

RM-V705U  
(provided)

## Audio Dubbing

You can record a new soundtrack on a prerecorded tape (normal audio only).

Perform steps **1**, **2** and **3** of the Insert Editing procedure (pg. 48) before continuing.

- The sound comes from the built-in microphone.

### FIND EDIT-IN POINT

- 1 Press **REW** to go a little beyond the beginning of the scene onto which you want to dub new audio, press **PLAY** to view the recorded tape, then press **PAUSE** at exactly the point where dubbing should start.

### ENGAGE AUDIO DUB-STANDBY MODE

- 2 Press and hold **A. DUB**, and without releasing **A. DUB**, press and release **PAUSE**.

### BEGIN AUDIO DUBBING

- 3 Press **PLAY**. When the counter reaches "0:00:00", Audio Dubbing stops automatically and the camcorder enters the Audio Dub-Standby mode.

### END AUDIO DUBBING

- 4 Press **STOP**.

### NOTES:

- Do not press **FF** or **REW** during Audio Dub-Standby, or the edit points will not be accurate.
- If the microphone is too close to the TV, or if the TV's volume is too high, whistling or howling may occur.

### NOTES (for Insert Editing and Audio Dubbing):

- Insert Editing and audio Dubbing may not work correctly if the tape contains blank segments, or if the recording speed was changed during the original recording.
- To edit/dub onto a tape, make sure the Erase Protection tab is in the position that allows recording. If not, slide the tab. Some cassettes have removable tabs. If the tab has been removed, cover the hole with adhesive tape.
- Do not press **STOP** during Insert Editing or Audio Dubbing, or the edit points will not be accurate.
- During Insert Editing and Audio Dubbing, when Insert-Pause or Audio Dub-Standby is engaged, the counter may go slightly past "0:00:00". Recording, however, stops at exactly 0:00:00.

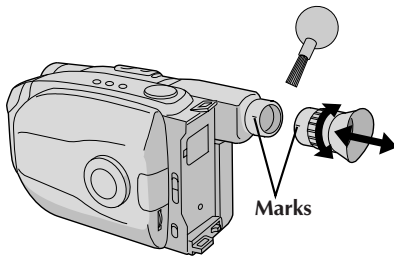
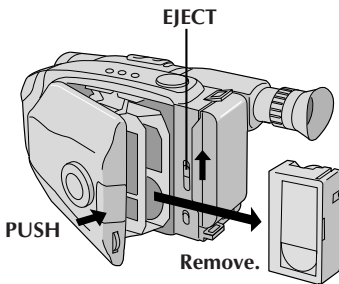
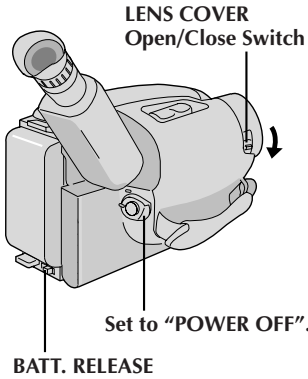

## After Use

- 1** Set the Power Switch to "POWER OFF" to turn off the camcorder.
- 2** Slide **EJECT** to open the cassette holder, then remove the cassette.
- 3** Close and lock the cassette holder by pressing **PUSH**.
- 4** Slide **BATT. RELEASE** to remove the battery pack.
- 5** Slide the **LENS COVER** open/close switch to close the lens cover.

## Cleaning The Camcorder

### CLEAN EXTERIOR

- 1** Wipe gently with a soft cloth.

### CLEAN LENS

- 2** Blow it with a blower brush, then wipe gently with lens cleaning paper.

### CLEAN VIEWFINDER

- 3**
  - ① Turn the eyepiece counterclockwise and pull it out.
  - ② Remove dust using a blower brush.
  - ③ Align the marks, re-attach the eyepiece and turn it clockwise.

### NOTES:

- Avoid using strong cleaning agents such as benzine or alcohol.
- Cleaning should be done only after the battery pack has been removed or other power units have been disconnected.
- Mold may form if the lens is left dirty.

SYMPTOM	POSSIBLE CAUSE(S)
<b>POWER</b>	
No power is supplied.	<ul style="list-style-type: none"> <li>● The battery pack has not been attached correctly (☞ pg. 8).</li> <li>● The battery pack is not charged (☞ pg. 8).</li> <li>● The power supply has not been correctly connected (☞ pg. 9).</li> </ul>
The power suddenly goes off and doesn't come back on by itself.	<ul style="list-style-type: none"> <li>● The battery pack has completely discharged.</li> <li>● Remove the cassette and disconnect the power source, then after a few minutes, try turning the power back on. If it still doesn't come on, consult your nearest JVC dealer.</li> </ul>
<b>RECORDING</b>	
Recording cannot be performed.	<ul style="list-style-type: none"> <li>● Make sure the Erase Protection tab is in the position that allows recording. If not, slide the tab. Some cassettes have removable tabs. If the tab has been removed, cover the hole with adhesive tape.</li> </ul>
Recording does not start.	<ul style="list-style-type: none"> <li>● The camcorder Power switch has not been set to "CAMERA" (☞ pg. 16).</li> </ul>
<b>PLAYBACK</b>	
The tape is running, but there's no playback picture.	<ul style="list-style-type: none"> <li>● The TV has not been set to its VIDEO mode or channel.</li> <li>● If A/V connection is used, the TV's VIDEO/TV switch has not been set to VIDEO.</li> <li>● The RF unit has not been set to the correct channel.</li> </ul>
Playback picture is blurred or interrupted.	<ul style="list-style-type: none"> <li>● The video heads are dirty or worn out. Consult your nearest JVC dealer for head cleaning or replacement.</li> </ul>
The counter indication is blurred during Still playback.	<ul style="list-style-type: none"> <li>● This is normal.</li> </ul>
<b>TAPE TRANSPORT</b>	
The tape stops during fast-forward or rewind.	<ul style="list-style-type: none"> <li>● The Counter Memory Function has been activated (☞ pg. 40).</li> </ul>
Rewinding or fast-forwarding cannot be performed.	<ul style="list-style-type: none"> <li>● The tape is already fully wound on one reel or the other.</li> </ul>

SYMPTOM	POSSIBLE CAUSE(S)
<b>OTHER</b>	
The tape won't eject.	<ul style="list-style-type: none"> <li>● The battery pack is running low.</li> </ul>
Some functions are not available.	<ul style="list-style-type: none"> <li>● The Select Dial is set to "AUTO LOCK".</li> </ul>
Vertical white lines appear when shooting a very bright object.	<ul style="list-style-type: none"> <li>● This sometimes occurs when the contrast between the background and the object is great. It is not a defect of the camcorder.</li> </ul>
Bright, crystal-shaped spots appear in the viewfinder.	<ul style="list-style-type: none"> <li>● Sunlight is directly entering the lens. This is not a defect of the camcorder.</li> </ul>
The viewfinder and the lens have become dirty (ex. fingerprints).	<ul style="list-style-type: none"> <li>● Wipe them gently with soft cloth.</li> </ul>
The picture is blurred in the Quick Review or Retake mode.	<ul style="list-style-type: none"> <li>● This is normal while recording in the EP mode. Some noise may be present while recording in the SP mode (☞ pg. 12).</li> </ul>
An error number (i.e. E03) appears.	<ul style="list-style-type: none"> <li>● Turn the camcorder's power off, then disconnect the power source. After a few minutes, try turning the power on again. If the error number still appears in the viewfinder, consult your nearest JVC dealer.</li> </ul>
The image is out of focus.	<ul style="list-style-type: none"> <li>● The diopter needs to be adjusted (☞ pg. 14).</li> <li>● The scene being shot is adversely affecting the operation of Auto Focus (☞ pg. 30).</li> </ul>
The date and time displays disappear.	<ul style="list-style-type: none"> <li>● If you remove the power source from the camcorder while the power is on, all settings and selections are erased. Make sure to turn the camcorder's power off before disconnecting the power source.</li> </ul>
The wrong date and time are displayed/recorded.	<ul style="list-style-type: none"> <li>● If you have not performed Date/Time Setting (☞ pg. 11), the date and time are not displayed/recorded correctly. Be sure that Date/Time setting is carried out.</li> </ul>
Even though the Lens Cover is open, the Lens Cover Warning indicator blinks.	<ul style="list-style-type: none"> <li>● The Lens Cover Warning indicator may blink when the camcorder is used in dark areas, regardless of the position of the Lens Cover.</li> </ul>

The camcorder is a microcomputer-controlled device. External noise and interference (from a TV, a radio, etc.) might prevent it from functioning properly. In such cases, first disconnect its power supply unit (battery pack, AC Power Adapter/Battery Charger, etc.) and clock battery; and then re-connect it and proceed as usual from the beginning.

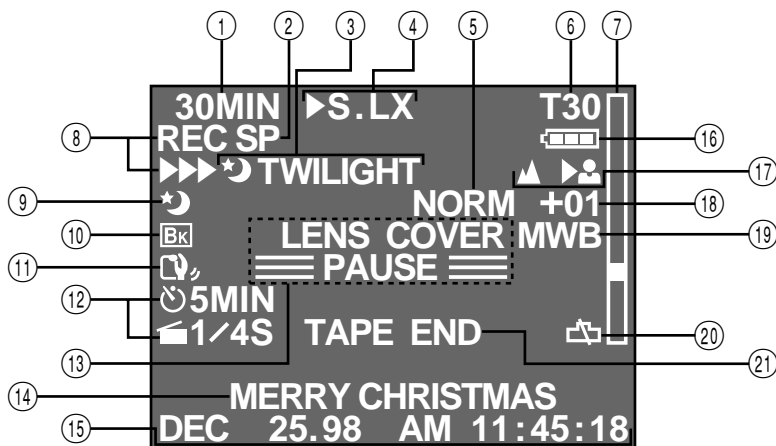





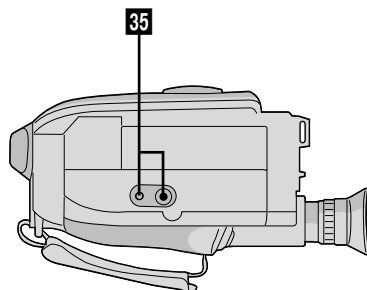
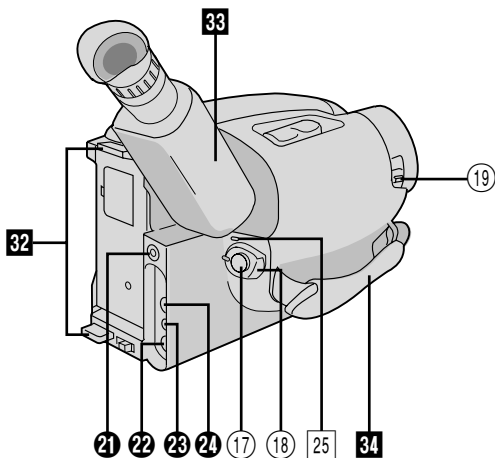
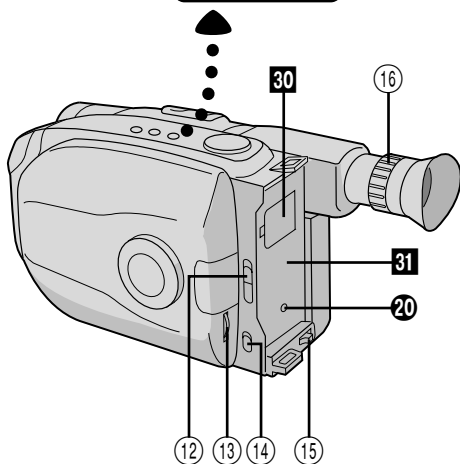
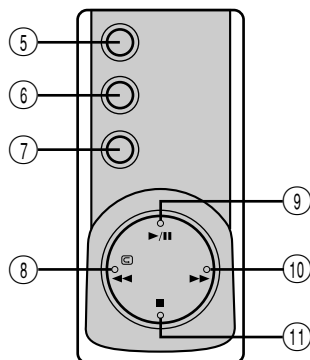
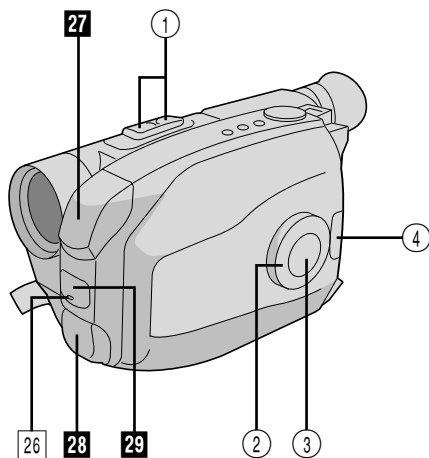



















### Viewfinder Indications





- ① Cassette Warning/  
Tape Remaining Time ..... pg. 17  
When no cassette is inserted: the cassette ( ) warning blinks.  
When Erase Protection tab is not in the position that allows recording: the cassette ( ) warning lights. Otherwise, the tape remaining time is displayed and the **tape remaining time warning** blinks when the tape is about to reach its end.  
When the Power Switch is set to "PLAY" and a tape is loaded: the cassette ( ) mark is displayed regardless of the Erase Protection tab's position.
- ② Recording Mode (SP/EP) Indicator ..... pg. 12
- ③, ⑨ Program AE Indicator ..... pg. 22  
Displayed at ③ for approx. 1 second when the Select Dial is switched from one position to another. Then only the indicator remains at ⑨.
- ③, ⑩ Fade/Wipe-Standby Indicator ..... pg. 24  
Displayed at ③ for approx. 2 seconds when the Fade/Wipe is switched from one function to another by pressing the EFFECT button. Then only the indicator remains at ⑩.
- ④ Multi-Function Control Indication ..... pg. 24  
Displayed when any of the buttons located on the Multi-Function Control is pressed. The indication disappears within approx. 2 seconds.
- ⑤ Super LoLux Indicator ..... pg. 25
- ⑥ Tape Length Indicator ..... pg. 12
- ⑦ Zoom Indicator Bar ..... pg. 18
- ⑧ Recording Indicator ..... pg. 16
- ⑪ Picture Stabilizer Indicator ..... pg. 19
- ⑫ Interval Timer/  
Recording Time Indicator ..... pg. 34
- ⑬ • Record-Standby Mode Indicator ..... pg. 16
- ⑭ • Lens Cover Warning: LENS COVER ... pg. 17
- ⑮ Instant Title Display ..... pg. 26
- ⑮ Date/Time Display ..... pg. 20
- ⑯ Battery Pack Remaining Power Indicator  
Changes as follows according to the battery pack's remaining power level:  
"". When the power is almost gone, the indicator "" blinks (**battery power warning**), then the unit shuts off. Replace the battery pack with a fully charged one.  
**Note:** The symbol containing 3 darkened squares — — does not necessarily mean that the battery pack is fully charged.
- ⑰ Focus Indicator ..... pg. 31
- ⑱ Exposure Control Level Counter ..... pg. 32
- ⑲ White Balance Mode Indicator ..... pg. 33
- ⑳ Clock Battery Warning  
Blinks for approx. 10 seconds when the power is turned on. This display also blinks when the clock (lithium) battery is either not installed or has discharged. Install or replace the old battery with a new one ( pg. 10).
- ㉑ • Tape End Display: TAPE END ..... pg. 17  
Appears when the end of the tape is reached during playback, recording or fast-forward.
- Condensation Warning:   
When this indication appears, all functions except tape eject and power on/off are disabled. Turn the unit off (without removing the power source) for a few hours, and when you turn it on again the indication should disappear.





## Controls

- ① Power Zoom Button .....  pg. 18
- ② Select Dial .....  pg. 22
- ③ Multi-Function Control
  - EFFECT Button .....  pg. 24
  - WIDE Button .....  pg. 25
  - TITLE Button .....  pg. 26
  - SUPER LOLUX Button .....  pg. 25
- ④ PUSH Button .....  pg. 13
- ⑤ Recording Mode [SP/EP] Button .....  pg. 12
- ⑥ DATE/TIME Button .....  pg. 20  
COUNTER R/M Button .....  pg. 40
- ⑦ P. [Picture] STABILIZER Button .....  pg. 19
- ⑧ REW Button .....  pg. 38  
RETAKE R [Quick Review] Button .....  pg. 19
- ⑨ PLAY/PAUSE Button .....  pg. 38
- ⑩ FF Button .....  pg. 38  
RETAKE F Button .....  pg. 19
- ⑪ STOP Button .....  pg. 38
- ⑫ EJECT Switch .....  pg. 13
- ⑬ Function Navigator Dial  
[MENU Jog Dial] .....  pg. 11
- ⑭ LIGHT OFF/AUTO/ON Switch .....  pg. 21
- ⑮ BATT. [Battery] RELEASE Switch .....  pg. 8
- ⑯ Diopter Adjustment .....  pg. 14
- ⑰ Recording Start/Stop Button .....  pg. 16
- ⑱ Power Switch .....  pg. 16, 38
- ⑲ LENS COVER Switch .....  pg. 16









## Connectors

- ⑳ DC IN Jack .....  pg. 9
- The jacks ㉑ to ㉒ are located beneath the jack cover.
- ㉑ J terminal [JLIP (Joint Level Interface Protocol) Connector.]
    - Connect the editing cable when performing Random Assemble Editing ( pg. 44 – 47).
    - It is used to connect the camcorder to a device such as a personal computer.  
For further details consult your nearest JVC dealer.
    - JLIP-controlled editing from camcorder to VCR is not possible if the VCR is not equipped with a J terminal.
  - ㉒ VIDEO OUT Connector .....  pg. 37
  - ㉓ RF DC OUT Connector .....  pg. 37
  - ㉔ AUDIO OUT Connector .....  pg. 37

## Indicators

- ㉕ Power Indicator .....  pg. 16
- ㉖ Tally Lamp .....  pg. 16

## Other Parts

- ㉗ Video Light .....  pg. 21
- ㉘ Microphone
  - Camera sensor  
Be careful not to cover this area; built-in here is the sensor necessary for shooting.
  - Remote Sensor .....  pg. 43
- ㉙ Clock Battery Compartment .....  pg. 10
- ㉚ Battery Pack Mount .....  pg. 8
- ㉛ Shoulder Strap Eyelets .....  pg. 15
- ㉜ Electronic Viewfinder .....  pg. 14
- ㉝ Grip Strap .....  pg. 14
- ㉞ Tripod Mounting Socket .....  pg. 15

**A**

AC Power Adapter .....	pg. 8
Animation Recording .....	pg. 35, 43
Audio Dubbing .....	pg. 49
Auto Date Record .....	pg. 20
Auto Focus .....	pg. 30
Auto Mode Lock Mode .....	pg. 23
Auto Mode Release Mode .....	pg. 23

**B**

Battery Pack .....	pg. 8, 57
Brighten the Image .....	pg. 32

**C**

Car Battery .....	pg. 9
Cassette Adapter .....	pg. 36
Charge Marker .....	pg. 9
Charging the Battery Pack .....	pg. 8
Clock (Lithium) Battery .....	pg. 10
Color Bar .....	pg. 29
Connection to a VCR/TV .....	pg. 37
Contents .....	pg. 7
Counter Memory .....	pg. 40

**D**

Darken the Image .....	pg. 32
Date/Time Insert .....	pg. 20
Date/Time Setting .....	pg. 11
DEMO Mode .....	pg. 29
Digital Zoom .....	pg. 18
Discharge the Battery pack .....	pg. 8
Diopter Adjust .....	pg. 14

**E**

Electronic Fog Filter Mode .....	pg. 23
Erase Protection .....	pg. 13
Exposure Control .....	pg. 32

**F**

Fade-in/out .....	pg. 24
Fast-Forward Tape .....	pg. 38

**G**

Grip Adjustment .....	pg. 14
-----------------------	--------

**H**

High Speed Shutter Mode .....	pg. 23
-------------------------------	--------

**I**

Index Code Marking .....	pg. 43
Insert Cassette .....	pg. 13
Insert Editing .....	pg. 48
Instant Titles .....	pg. 26

**M**

Manual Focus .....	pg. 31
MBR Code Setting .....	pg. 44

**N**

ND Effect Mode .....	pg. 23
Nega/Posi Mode .....	pg. 23

**P**

Picture Stabilizer .....	pg. 19
Playback .....	pg. 38
Program AE with Special Effects .....	pg. 22, 23
Provided Accessories .....	pg. 6

**Q**

Quick Review .....	pg. 19
--------------------	--------

**R**

Random Assemble Editing .....	pg. 44–47
Recording, Advanced Features .....	pg. 22–35
Recording .....	pg. 16
Recording, Start/Stop .....	pg. 16, 17
Recording Mode Setting .....	pg. 12
Record-Standby .....	pg. 16
Remote Control Unit .....	pg. 42
Remove Cassette .....	pg. 13
Retake .....	pg. 19
Rewind Tape .....	pg. 38

**S**

Self-Timer .....	pg. 34, 43
Sepia Mode .....	pg. 23
Shoulder Strap Attachment .....	pg. 15
Shuttle Search .....	pg. 40
Specifications .....	pg. 59
Sports Mode .....	pg. 23
Still Playback .....	pg. 40
Super LoLux .....	pg. 25

**T**

Tape Counter .....	pg. 38
Tape Dubbing .....	pg. 41
Tape Length Setting .....	pg. 12
Time-Lapse Shooting .....	pg. 35, 43
Tracking .....	pg. 39
Tripod Mounting .....	pg. 15
Twilight Mode .....	pg. 23

**V**

Video Light .....	pg. 21
Viewfinder Adjustment .....	pg. 14
Viewfinder, indications .....	pg. 53

**W**

White Balance Adjustment .....	pg. 33
Wide Mode .....	pg. 25
Wipe-in/out .....	pg. 24

**Z**

Zooming .....	pg. 18
---------------	--------



## DANGER:

### Video Light

- The video light becomes extremely hot. Do not touch it either while in operation or soon after turning it off, otherwise serious injury may result.
- Do not place the camcorder into the carrying case immediately after using the video light, since it remains extremely hot for some time.
- When operating, keep a distance of about 30 cm (1 ft.) between the video light and people or object.
- Do not use near flammable or explosive materials.
- It is recommended that you consult your nearest JVC dealer for replacing the video light.

### When using the AC Power Adapter/Charger in areas other than the USA

- The provided AC Power Adapter/Charger features automatic voltage selection in the AC range from 110 V to 240 V.

### USING HOUSEHOLD AC PLUG ADAPTER

In case of connecting the unit's power cord to an AC wall outlet other than American National Standard C73 series type use an AC plug adapter, called a "Siemens Plug", as shown.

For this AC plug adapter, consult your nearest JVC dealer.

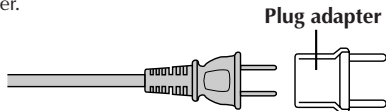

### INFORMATION

This device complies with Part 15 of FCC Rules. Operation is subject to the following two conditions: (1) This device may not cause harmful interference, and (2) this device must accept any interference received, including interference that may cause undesired operation. Change or modifications not approved by the party responsible for compliance could void the user's authority to operate the equipment. This equipment has been tested and found to comply with the limits for a Class B digital device, pursuant to Part 15 of the FCC Rules. These limits are designed to provide reasonable protection against harmful interference in a residential installation. This equipment generates, uses, and can radiate radio frequency energy and, if not installed and used in accordance with the instructions, may cause harmful interference to radio communications. However, there is no guarantee that interference will not occur in a particular installation. If this equipment does cause harmful interference to radio or television reception, which can be determined by turning the equipment off and on, the user is encouraged to try to correct the interference by one or more of the following measures:

- Reorient or relocate the receiving antenna.
- Increase the separation between the equipment and receiver.
- Connect the equipment into an outlet on a circuit different from that to which the receiver is connected.
- Consult the dealer or an experienced radio/TV technician for help.

## General Battery Precautions

- When the C-P6U or C-P7U (cassette adapter) is not functioning even when correctly operated, the battery is exhausted. Replace it with a fresh one.
- Use only the following battery:  
C-P6U or C-P7U ..... AA (R6) size

Please make note of the following rules for battery use. When misused, battery can leak or explode.

1. Refer to the C-P6U/C-P7U instructions when replacing the battery.
2. **Do not** expose the battery to excessive heat as it can leak or explode.
3. **Do not** dispose of battery in a fire.
4. Remove battery from the unit if it is to be stored for an extended period to avoid battery leakage which can cause malfunctions.

## Battery Packs

The supplied battery pack is a nickel-cadmium battery. Before using the supplied battery pack or an optional battery pack, be sure to read the following cautions:

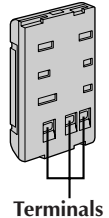

1. **To avoid hazard . . .**
  - ..... **do not** burn.
  - ..... **do not** short-circuit the terminals.
  - ..... **do not** modify or disassemble.
  - ..... use only specified chargers.
2. **To prevent damage and prolong service life . . .**
  - ..... **do not** subject to unnecessary shock.
  - ..... avoid repeated charging without fully discharging.
  - ..... charge in an environment where temperatures are within the tolerances shown in the chart below. This is a chemical reaction type battery—cooler temperatures impede chemical reaction, while warmer temperatures can prevent complete charging.
  - ..... store in a cool, dry place. Extended exposure to high temperatures will increase natural discharge and shorten service life.
  - ..... avoid prolonged uncharged storage.
  - ..... remove from charger or powered unit when not in use, as some machines use current even when switched off.

## NOTES:

- *It is normal for the battery pack to be warm after charging, or after use.*  
Temperature Range Specifications  
Charging ..... 10°C to 35°C (50°F to 95°F)  
Operation ..... 0°C to 40°C (32°F to 104°F)  
Storage ..... -10°C to 30°C (14°F to 86°F)
- *Recharging time is based on room temperature of 20°C.*
- *The lower the temperature, the longer recharging takes.*

## Cassettes

To properly use and store your cassettes, be sure to read the following cautions:

### 1. During use . . .

- .... make sure the cassette bears the VHS-C mark.
- .... be aware that recording onto prerecorded tapes automatically erases the previously recorded video and audio signals.
- .... make sure the cassette is positioned properly when inserting.
- .... do not load and unload the cassette repeatedly without allowing the tape to run at all. This slackens the tape and can result in damage.
- .... do not open the front tape cover. This exposes the tape to fingerprints and dust.

### 2. Store cassettes . . .

- .... away from heaters or other heat sources.
- .... out of direct sunlight.
- .... where they won't be subject to unnecessary shock or vibration.
- .... where they won't be exposed to strong magnetic fields (such as those generated by motors, transformers or magnets).
- .... vertically, in their original cases.

## Main Unit

### 1. For safety, DO NOT . . .

- .... open the camcorder's chassis.
- .... disassemble or modify the unit.
- .... short-circuit the terminals of the battery pack. Keep it away from metallic objects when not in use.
- .... allow inflammables, water or metallic objects to enter the unit.
- .... remove the battery pack or disconnect the power supply while the power is on.
- .... leave the battery pack attached when the camcorder is not in use.

### 2. Avoid using the unit . . .

- .... in places subject to excessive humidity or dust.
- .... in places subject to soot or steam such as near a cooking stove.
- .... in places subject to excessive shock or vibration.
- .... near a television set.
- .... near appliances generating strong magnetic or electric fields (speakers, broadcasting antennas, etc.).
- .... in places subject to extremely high (over 40°C or 104°F) or extremely low (under 0°C or 32°F) temperatures.

### 3. DO NOT leave the unit . . .

- .... in places of over 50°C (122°F).
- .... in places where humidity is extremely low. (below 35%) or extremely high (above 80%).
- .... in direct sunlight.
- .... in a closed car in summer.
- .... near a heater.

### 4. To protect the unit, DO NOT . . .

- .... allow it to become wet.
- .... drop the unit or strike it against hard objects.
- .... subject it to shock or excessive vibration during transportation.
- .... keep the lens directed at extremely bright objects for long periods.
- .... direct the eyepiece of the viewfinder at the sun.
- .... carry it by holding the viewfinder. Be sure to hold the main unit with both hands or use the grip.
- .... swing it excessively when using the shoulder strap.



### About moisture condensation . . .

- You may have observed that pouring a cold liquid into a glass will cause drops of water to form on the glass' outer surface. This same phenomenon occurs on the head drum of a camcorder when it is moved from a cool place to a warm place, after heating a cold room, under extremely humid conditions or in a place directly subjected to the cool air from an air conditioner.
- Moisture on the head drum can cause severe damage to the video tape, and can lead to internal damage to the camcorder itself.

### Serious malfunctioning

If malfunctioning occurs, stop using the unit immediately and consult your local JVC dealer.

## GENERAL

Format	: VHS NTSC standard
Power source	: DC 6V 
Power consumption	
light on	: 8.0 W
light off	: 5.1 W
Signal system	: NTSC-type
Video recording system	
Luminance	: FM recording
Color	: Converted sub-carrier direct recording Conforms to VHS standard
Cassette	:  cassette
Tape speed	
SP	: 33.35 mm/sec. (1-5/16 ips)
EP	: 11.12 mm/sec. (7/16 ips)
Recording time (max.)	
SP	: 40 minutes
EP	: 120 minutes (with TC-40 cassette)
Operating temperature	: 0°C to +40°C (32°F to 104°F)
Operating humidity	: 35% to 80%
Storage temperature	: -20°C to +50°C (-4°F to 122°F)
Weight	: Approx. 790 g (1.8 lbs)
Dimensions (Including viewfinder)	: 113 (W) x 117 (H) x 222 (D) mm (4-1/2" x 4-5/8" x 8-3/4")

## CAMERA

Pick up	: 1/4" format CCD
Lens	: F1.6, f = 3.8 to 83.6 mm, 22:1 power zoom lens with auto iris and macro control, filter diameter 46 mm
Viewfinder	: Electronic viewfinder with 0.55" color LCD
White balance adjustment	: Auto/Manual adjustment



## VIDEO

Output	: 1 Vp-p, 75 ohms, unbalanced (via VIDEO OUT connector)
--------	---

## AUDIO

Output	: -8 dBs, 1 k-ohm (via AUDIO OUT connector)
--------	---

## AC POWER ADAPTER/BATTERY CHARGER (AA-V15U)

Power requirement	
U.S.A. and Canada	: AC 120 V~, 60 Hz
Other countries	: AC 110 V to 240 V~, 50/60 Hz
Power consumption	: 23 W
Output	
Charge	: DC 8.5 V  , 1.3 A
VTR	: DC 6.3 V  , 1.8 A
Charging system	: Constant current, peak detection, timer controlled
Dimensions	: 140 (W) x 42 (H) x 68 (D) mm (5-9/16" x 1-11/16" x 2-11/16")
Weight	: Approx. 300 g (0.71 lbs)

## CASSETTE ADAPTER (C-P7U)

Dimensions	: 188 (W) x 25 (H) x 104 (D) mm (7-7/16" x 1" x 4-1/8")
Weight	: Approx. 240 g (0.53 lbs)
Accessory	: "AA (R6)"-size battery x 1

## Provided Accessories ..... pg. 6

### Optional Accessories

- Battery Packs BN-V12U, BN-V22U, BN-V25U
- Car Battery Charger BH-V3U
- Battery Charger BH-VC10U
- Car Battery Cord AP-V7U
- RF Unit RF-V5U
- Compact VHS-C Cassettes TC-40/30/20
- Active Carrying Bag CB-V7U
- Remote Control Unit RM-V700U

Some accessories are not available in some areas. Please consult your nearest JVC dealer for details on accessories and their availability.

**Specifications shown are for SP mode unless otherwise indicated.  
E. & O. E. Design and specifications subject to change without notice.**

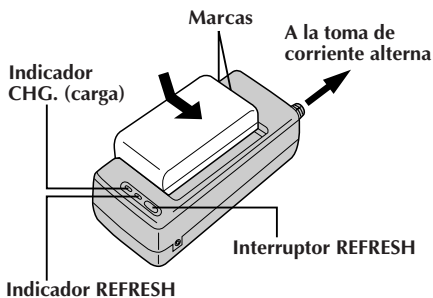
**REFRESCADO**

El adaptador de CA se caracteriza por la función REFRESH que le permite descargar totalmente la batería antes de recargarla. Efectúe la función REFRESH después de un mínimo de 5 cargas.

**Para descargar las baterías . . .**

..... coloque la batería en el adaptador como se muestra en la ilustración arriba. Luego presione REFRESH. El indicador REFRESH se enciende cuando se inicia la descarga y se apaga cuando la descarga ha terminado.

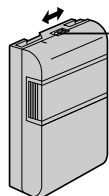
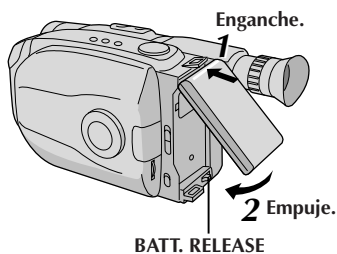

Indicador de carga

**INDICADOR DE CARGA**

Se ha suministrado un indicador de carga sobre la batería para ayudarle a recordar si ha sido cargado o no. Los dos colores suministrados (rojo y negro), le permiten seleccionar la carga y la descarga.

**ATENCIÓN:**

Antes de desmontar la fuente de alimentación, asegúrese que la alimentación de la cámara de video esté desconectada. El no hacerlo puede producir una falla de funcionamiento en la cámara de video.

**Alimentación**

Esta cámara de video posee un sistema de alimentación de 3 vías que le permite seleccionar la fuente de alimentación más apropiada.

**NOTAS:**

- Sin alimentación no hay ninguna función disponible.
- Utilice exclusivamente la alimentación indicada.
- No utilice la unidades de alimentación suministradas con otro equipo.

**CARGA DE LA BATERIA****ALIMENTACION**

- 1 Conecte el cable de alimentación de CA del cargador a una toma de corriente.

**COLOCACION DE LA BATERIA**

- 2 Alinee las marcas y deslice la batería en la dirección de la flecha hasta que quede bloqueada en su lugar. El indicador CHG. comienza a parpadear indicando que se ha iniciado la carga.

**EXTRACCION DE LA BATERIA**

- 3 Cuando el indicador CHG. para de destellar, pero continúa encendido, la carga ha terminado. Deslice la batería en el sentido opuesto al de la flecha.

BATERIA	CARGA	DESCARGA
BN-V12U	aprox. 1 h 10 m	aprox. 3 h 30 m
BN-V18U	aprox. 1 h 40 m	aprox. 5 h 30 m
BN-V22U	aprox. 2 h 10 m	aprox. 7 h
BN-V25U	aprox. 2 h 40 m	aprox. 10 h

**USO DE LA BATERIA****COLOCACION DE LA BATERIA**

- 1 Enganche la parte superior del mismo en la cámara de video y empújela hasta que se bloquee en su lugar.

**EXTRACCION DE LA BATERIA**

- 2 Deslice **BATT. RELEASE** y extraiga la batería.

BATERIA	Tiempo de grabación aproximado (unidad: min)
BN-V12U	75 ( 40 )
BN-V18U	110 ( 65 )
BN-V22U	150 ( 90 )
BN-V25U	200 ( 120 )

( ) : cuando el foco de video está encendido.

Si la unidad comienza a funcionar mal, deje de usarla inmediatamente y consulte a su concesionario local de JVC.

## ALIMENTACION

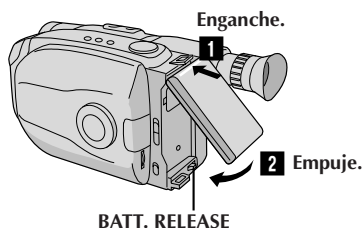

### Utilización de la batería

- 1** Enganche el extremo superior de la batería en la cámara de video. (Procedimiento para carga, ☞ P. 8)
- 2** Empuje la batería hacia adentro hasta que quede bloqueada en su lugar.

### Para extraer la batería

Deslice **BATT. RELEASE** y extraiga la batería.

## INSERCIÓN DEL CASSETTE DE VIDEO

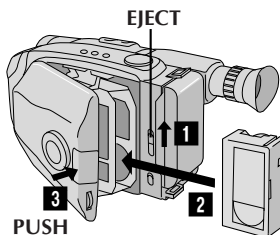

- 1** Deslice **EJECT** para abrir el portacassette.
- 2** Inserte cassette de video.
- 3** Presione **PUSH** para cerrar el portacassette. (Por más detalles, ☞ P. 13.)

## REPRODUCCION

PLAY/PAUSE (reproducción/pausa) **3**

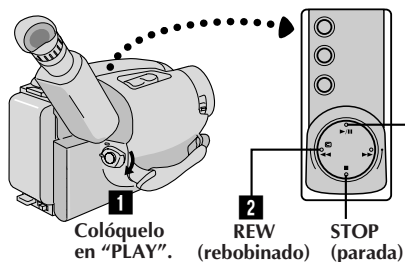

- 1** Ajuste el interruptor de alimentación en "PLAY".
  - 2** Presione **REW**.  
— La cinta se detiene automáticamente al comienzo de la misma.
  - 3** Presione **PLAY/PAUSE**.  
— Comienza la reproducción y la imagen aparece.
- Presione **STOP** para detener la grabación. (Por más detalles, ☞ P. 38.)

**O simplemente reproduzca la cinta en un VCR de VHS utilizando el adaptador de cassette (VHS Playpak). ☞ P. 36**

## FILMACION

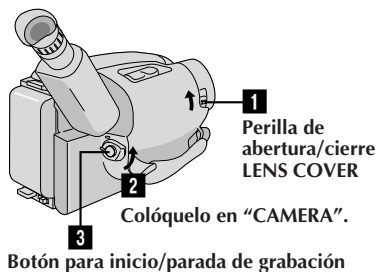

- 1** Deslice la perilla de apertura/cierre **LENS COVER** para abrir la tapa del objetivo.
  - 2** Ajuste el interruptor de alimentación en "CAMERA".  
— El indicador de alimentación se encenderá y aparecerá una imagen.
  - 3** Presione el botón inicio/parada de grabación.  
— Comenzará la grabación.
- Para detener temporariamente la grabación, presione nuevamente el botón de inicio/parada de grabación. (Por más detalles, ☞ P. 16, 17.)

**HOW TO LOCATE YOUR JVC SERVICE CENTER****TOLL FREE: 1-800-252-5722****Dear customer:**

In order to receive the most satisfaction from your purchase, read the instruction booklet before operating the unit. In the event that repair is necessary, or for the address nearest your location, please refer to the factory service center list below or within the Continental United States, call 1-800-252-5722 for your authorized servicer. Remember to retain your Bill of Sale for Warranty Service.

— JVC

**JVC SERVICE & ENGINEERING  
COMPANY OF AMERICA  
DIVISION OF US JVC CORP.**

## FACTORY SERVICE CENTER LOCATIONS

107 Little Falls Road  
Fairfield, NJ 07004-2105  
(973) 808-9279

5665 Corporate Avenue  
Cypress, CA 90630-4727  
(714) 229-8011

230 Eliot Street  
Ashland, MA 01721-2377  
(508) 881-5923

1500 Lakes Parkway  
Lawrenceville, GA 30243-5857  
(770) 339-2522

10700 Hammerly Blvd., Suite 110  
Houston, TX 77043-2310  
(713) 935-9331

8192 West State Road 84  
Davie, FL 33324-4611  
(954) 472-1960

705 Enterprise Street  
Aurora, IL 60504-8135  
(630) 851-7855

2969 Mapunapuna Place, Suite 101  
Honolulu, HI 96819-2000  
(808) 833-5828

890 Dubuque Avenue  
South San Francisco, CA 94080-1804  
(415) 871-2666

*Sophisticated electronic products may require occasional service. Just as quality is a keyword in the engineering and production of the wide array of JVC products, service is the key to maintaining the high level performance for which JVC is world famous. The JVC service and engineering organization stands behind our products.*

NATIONAL HEADQUARTERS  
JVC SERVICE & ENGINEERING COMPANY OF AMERICA  
DIVISION OF US JVC CORP.  
107 Little Falls Road  
Fairfield, NJ 07004-2105

***If you ship the product...***

*Pack your JVC unit in the original carton or one of equivalent size and strength. Enclose, with the unit, a letter stating the problem or symptom that exists and also a copy of the receipt or bill of sale you received when you purchased your JVC unit. Print your home return address on the outside and the inside of the carton. Send to the appropriate JVC Factory Service Center as listed above.*

**ACCESSORIES**

To purchase accessories for your JVC product, you may contact your local JVC Dealer.  
Or from the 48 Continental United States call toll free:  
1-800-882-2345.

**Don't service it yourself.****CAUTION**

To prevent electrical shock, do not open the cabinet. No user serviceable parts inside.  
Refer servicing to qualified service personnel.

**LIMITED WARRANTY****CONSUMER VIDEO 1-90**

JVC COMPANY OF AMERICA warrants this product and all parts thereof, except as set forth below **ONLY TO THE ORIGINAL PURCHASER AT RETAIL** to be **FREE FROM DEFECTIVE MATERIALS AND WORKMANSHIP** from the date of original retail purchase for the period as shown below. ("The Warranty Period")

PARTS	<b>1</b> YR	LABOR	<b>90</b> DAYS
-------	-------------	-------	----------------

THIS LIMITED WARRANTY IS VALID ONLY IN THE FIFTY (50) UNITED STATES, THE DISTRICT OF COLUMBIA AND IN COMMONWEALTH OF PUERTO RICO.

**WHAT WE WILL DO:**

If this product is found to be defective, JVC will repair or replace defective parts at no charge to the original owner. Such repair and replacement services shall be rendered by JVC during normal business hours at JVC authorized service centers. Parts used for replacement are warranted only for the remainder of the Warranty Period. All products and parts thereof may be brought to a JVC authorized service center on a carry-in basis except for Television sets having a screen size 25 inches and above which are covered on an in-home basis.

**WHAT YOU MUST DO FOR WARRANTY SERVICE:**

Return your product to a JVC authorized service center with a copy of your bill of sale. For your nearest JVC authorized service center, please call toll free: (800) 252-5722.

If service is not available locally, box the product carefully, preferably in the original carton, and ship, insured, with a copy of your bill of sale plus a letter of explanation of the problem to the nearest JVC Factory Service Center, the name and location of which will be given to you by the toll-free number.

If you have any questions concerning your JVC Product, please contact our Customer Relations Department.

**WHAT IS NOT COVERED:**

This limited warranty provided by JVC does not cover:

1. Products which have been subject to abuse, accident, alteration, modification, tampering, negligence, misuse, faulty installation, lack of reasonable care, or if repaired or serviced by anyone other than a service facility authorized by JVC to render such service, or if affixed to any attachment not provided with the products, or if the model or serial number has been altered, tampered with, defaced or removed;
2. Initial installation and installation and removal for repair;
3. Operational adjustments covered in the Owner's Manual, normal maintenance, video and audio head cleaning;
4. Damage that occurs in shipment, due to act of God, and cosmetic damage;
5. Signal reception problems and failures due to line power surge;
6. Video Pick-up Tubes/CCD Image Sensor, Cartridge, Stylus (Needle) are covered for 90 days from the date of purchase;
7. Accessories;
8. Batteries (except that Rechargeable Batteries are covered for 90 days from the date of purchase);from the date of purchase);

There are no other express warranties except as listed above.

THE DURATION OF ANY IMPLIED WARRANTIES INCLUDING THE IMPLIED WARRANTY OF MERCHANTABILITY, IS LIMITED TO THE DURATION OF THE EXPRESS WARRANTY HEREIN.

JVC SHALL NOT BE LIABLE FOR THE LOSS OF USE OF THE PRODUCT, INCONVENIENCE, LOSS OR ANY OTHER DAMAGES, WHETHER DIRECT, INCIDENTAL OR CONSEQUENTIAL (INCLUDING, WITHOUT LIMITATION, DAMAGE TO TAPES, RECORDS OR DISCS) RESULTING FROM THE USE OF THIS PRODUCT, OR ARISING OUT OF ANY BREACH OF THIS WARRANTY. ALL EXPRESS AND IMPLIED WARRANTIES, INCLUDING THE WARRANTIES OF MERCHANTABILITY AND FITNESS FOR PARTICULAR PURPOSE, ARE LIMITED TO THE WARRANTY PERIOD SET FORTH ABOVE.

Some states do not allow the exclusion of incidental or consequential damages or limitations on how long an implied warranty lasts, so these limitations or exclusions may not apply to you. This warranty gives you specific legal rights and you may also have other rights which vary from state to state.

JVC COMPANY OF AMERICA  
DIVISION OF US JVC CORP.

41 Slater Drive  
Elmwood Park, New Jersey 07407

REFURBISHED PRODUCTS CARRY A SEPARATE WARRANTY, THIS WARRANTY DOES NOT APPLY. FOR DETAILS OF REFURBISHED PRODUCT WARRANTY, PLEASE REFER TO THE REFURBISHED PRODUCT WARRANTY INFORMATION PACKAGED WITH EACH REFURBISHED PRODUCT.

**For customer use:**

Enter below the Model No. and Serial No. which is located either on the rear, bottom or side of the cabinet. Retain this information for future reference.

**Model No.:** \_\_\_\_\_**Serial No.:** \_\_\_\_\_**Purchase date:** \_\_\_\_\_**Name of dealer:** \_\_\_\_\_



# JVC

**JVC COMPANY OF AMERICA**  
DIVISION OF US JVC CORP.  
41 Slater Drive, Elmwood Park, N.J. 07407

**JVC CANADA INC.**  
21 Finchdene Square,  
Scarborough Ontario M1X 1A7